

# Sea Scout Book



# Sea Scout Handbook

## Thanks to all contributors

The national sea Scout team  
Tommy Myler  
Brian Gaule  
John McKeivitt  
Pauline Lucas  
Tom McMullen

## Special thanks to

Zef Klinkerberg  
Gerry Hickey  
Brian O'Daly  
Eoghan Lavelle  
Jimmy Myler  
Eugene Mc Hugh  
Tommy Taylor

## Editors/Proofing

Niall McCooey  
Cian O'Gradaigh

## Mike McKillen

## Layout/design

Fiona Sullivan

## Graphics

Marie Louise Fitzpatrick  
Eoghan Lavelle  
Cian O'Gradaigh  
Gerry Hickey  
Barry Semple

## Technicla support

Aaron Bohan  
Stephen Taylor

# Contents

Sea Scouting Ireland	5	Walking a bearing	114
Progressive Badge Scheme	7	The sky at night	115
Attainment badges	8	Identifying a feature	116
Scout Promise	9	Cross bearings	117
History of Scouting	10	Route planning	118
Scout Law	12	Navigation techniques	120
Bullying	14	Navigation using a map	121
Spirituality in Scouting	14	Sending for help	122
Scout Motto	15	Inland waterway navigation	124
Structure of Troop	16	Marine Compass	126
Sea Scout Uniform	18	Costal Navigation	128
Drill	19		
Sign, Salute & handshake	20	The environment	131
Investiture	22		
Nautical traditions	23	Day Hike gear	133
Flags	25	Kit List	135
		Personal Clothing	136
Ropework	28	Layered approach	137
Pioneering	32	Backpacks	138
		Equipment	139
Heaving a line	36	Hiking Boots	140
		Group equipment	141
First aid	37	Hike Tents	142
Artificial respiration	46	Lightweight stoves	143
		Backpackers menu	144
Swimming	48	Emergency rations	145
Lifejackets and Bouyancy Aids	50		
Safety Afloat	52	Personal gear	146
Clothing for water activities	54	Group equipment	147
Types of rowing craft	55	Choose a campsite	148
Boat construction	56	Tents	149
Parts of a boat	57	Pitching your tent	150
Getting into a small boat	58	Setting up camp	151
Rowing - dinghy	59	Altar fires	152
Rowing - Boat drill	60	Lighting a fire	153
Sailing	63	Fires	154
Capsize drill	70	Axe and saw	155
Powerboating	72	Clasp knife	156
Types of craft	79	Cooking	157
Canoeing	80	Menus and camp costs	158
Rafting	86	Backwoods cooking	159
Boat maintenance	88	Bivouacs	160
		Eco camping	161
Anchoring	90	Striking Camp	162
Tides and currents	92		
Distress Signals	94	Fitness	163
Buoyage	97	Your health	164
Rules of the road	100	Your Body	165
Marine VHF	102		
		Nautical sea terms	166
Weather forecasts	105		
		Progressive badge scheme	168
Maps	109		
Compass	112		



# Sea Scouting Ireland

## **Welcome Aboard:**

Welcome abroad – to the challenge and adventure of Sea Scouting, a programme combining the tradition of the past with the technology of the future.

## **Opportunity for Challenge & Adventure**

Sea scouting is involved in a wide range of activities, some are water-based other are shore-based and some are even a combination of shore and water. A Sea Scout should be amphibious. When getting out on the water, Sea Scouts can use a variety of craft:- from rafts, powerboats, and canoes to large sailing yachts. But no matter how you get afloat, you'll discover a thrill that you just can't get anywhere else.

The outdoors is no place for the unwary and the Scout motto, "Be Prepared", is seriously practiced here. The challenge is being able to take your vessel from point A to point B, while being ready for whatever you may encounter along the way. This is what makes Scouting great.

Its not just about activities such as camping, sailing, hiking and canoeing, its about developing in you the skills such as teamwork, decision making, problem solving, leadership and self reliance.

## **Opportunity for Friendship:**

Even if you know nothing about surviving the "Great Outdoors", don't worry you will. You'll have a chance to grow and share your experiences with others. You can meet other Scouts at local, regional, national or inter-national events.

## **Opportunity for Service:**

Scouting has been of service to communities across the world. Service can be expressed in individual good turns or in organised projects involving your Watch or the whole Troop. In rescues at sea or facing emergencies on shore, Scouts have saved lives and property.

## **Opportunity for Leadership:**

Sea Scout programmes are planned and run by the youth members, with the support of adult Leaders. As being a member of a boat's crew teaches you teamwork, so does being a member of a Watch. As you gain experience you will be given the opportunity to contribute to the leadership of the Watch and Troop. The leadership skills you learn in Scouting will last your lifetime.

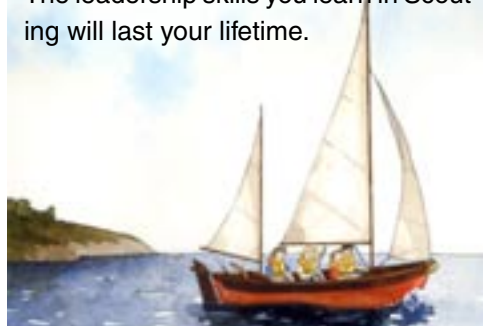

# Sea Scouting Ireland

## **Opportunity for Advancement:**

In Scouting, you are acknowledged for the things you learn and do. The Sea Scout progressive training programme rewards the effort you put into it and not necessarily whether you get it right or wrong. Scouting believes in a “Doing your best” approach. Each level of advancement marks your growth as a Scout and a potential leader. The pinnacle of the progressive scheme is the “Mariner” badge, the highest Sea Scouting award.

## **Sea Scouting’s Traditions:**

Seafaring has traditions that go back hundreds of years. Sea Scouting has adapted these traditions to its programmes and in the process has created a tradition of its own. In this book, you will see names and phrases that are not used in “Lands-person” language. These terms and practices continue to exist because they have a purpose.

As a Sea Scout, you become part of that tradition and you get to play your part in shaping that tradition for future Sea Scouts.

## **Your Duties as a Sea Scout:**

When you become a member, take part in the activities. Dedicate yourself to the ideals of Scouting by trying to live up to the Scout Promise and Law, they’ll keep you on the right course.

Participate wholeheartedly in the meetings and activities. Don’t be afraid to offer suggestions. The Troop’s programme is based on your needs and desires as well as those of the other members. Voice your opinion on who your Watch Leader should be, but do it with consideration. Then give the Watch Leader your full support.

Your Troop operates on a budget. Pay your dues and lend a hand when there is need to earn funds. And don’t hesitate to ask your Skipper for help when you need it. He or She is there to see that you don’t go too far off course.

## **How to Join:**

To join you must be 11 years of age or in some Troops 12 years of age. You can stay in Sea Scouting until you are 17 years of age or again some Troops only up until 16 years old when you can move on to Ventures or become an instructor. Sea Scouting is for everyone. Tell your friends!



# Progressive Badge Scheme



MEMBERSHIP

The first stage for the training scheme in Sea Scouts is the Membership Badge. This is followed by the Sea Scout Badge which is aimed at 11-13 year olds. The Boatman Badge is suitable for 13-14 year olds and the Coxswain Badge for 14/16 year olds. The Mariner Badge is aimed at WLs and Venture Scouts.



BOATMAN



SEA SCOUT

1. Membership Badge - Investiture
2. Sea Scout Badge - Finding your Way in Sea Scouting.
3. Boatman Badge - Guided to Self Reliance.
4. Coxswain Badge - Supporting the Team.
5. Mariner Badge - Leading the Team.



COXWAIN



MARINER



# Attainment Badges



CAMP SKILLS



EXPEDITION



CAMPING



ROWING

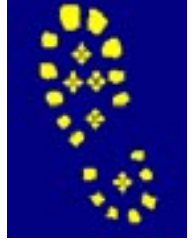

HIKING



POWER BOATING

As you make your way through Scouting, you have the opportunity to gain some further specialised badges called “Attainment Badges”. The majority of the tasks for these badges is contained in the training scheme and the additional tasks are easily achievable with a bit more effort. We have used the term “Attainment Badges” because it means, “to gain by effort”. This is the type of Sea Scouting we are trying to encourage, Sea Scouts that “Try to do their Best” and not always just get the right answer. Sometimes to get it “wrong” teaches us more than getting it “right”.



SAILING



CYCLING



SWIMMING



BACKWOODS



CANOEING



RAFTING



FIRST-AID



SURVIVAL



# Scout Promise

Being a Scout brings with it responsibilities. One of these is to live up to the Scout Promise. The Promise and Law is very important to Scouting as it sums up what a Scout should be. The Promise is a personal commitment by you to do the best you can.

**On my honour I Promise  
that I will do my best,  
To do my duty to God  
and to my Country,  
To help other people  
and to keep the Scout Law.**

**Geallaim dar m'onór,  
Mo dhícheall a dhéanamh,  
Mo dhualgas do mo Dhia  
agus mo thír a chomhlíonadh,  
Cabhrú le daoine eile  
Agus dlí na nGasóga a  
choimead**

**On my honour I Promise that I will  
do my best,**

You are making a personal commitment to the "Best" of your ability, not to anyone else's best. Every Scout is an individual and your best is a personal challenge.

**To do my duty to God and to my Country,** Observe your religious beliefs and above all respect those of others.

Our Country provides us with clothing, food, employment, education, health care, housing, etc. For example we can do our duty by observing and obeying laws and those who enforce them, the Gardai. What would the Country be like if there were no laws, imagine if it was optional which side of the road you drive on, everybody trying to go in different directions at the same time?

Respect our Country – pollution, litter, and the environment. Respect the National flag, respect for other Countries and their customs and cultures.

**To help other people and to keep the Scout law.**

As you go through your day to day life, try to help someone in whatever way you can. Sometimes a small bit of help can be of great benefit to the person in need of help.



# History of Scouting



Robert Stephenson Smythe Baden-Powell, known as “BP”, founded Scouting in 1907. “BP” was born on 22<sup>nd</sup> February 1857, he enjoyed playing soccer, the piano, drawing and painting, acting, sailing and generally loving an outdoor life.

When “BP” left school he joined the army and during the Boer War (1899 –1901) he became a popular hero when he defended the little town of Mafeking for 217 days against a much larger Boer army.

In Mafeking he discovered that given trust and some training boys, could not only be very useful but also enjoyed being useful.

In August 1907 he invited some boys to camp on Brownsea Island, Poole harbour. Here the boys camped (unusual in those days) and were introduced to such things as signalling, tracking, knotting and first aid.

Following the success of the camp “BP” published “Scouting for Boys” in 1908, and to his surprise thousands of boys spontaneously formed themselves into “Scout Patrols”, who then sought adult leaders to help them. In this unique way the Scout movement began. It is important to note that it was the boys themselves that made Scouting happen; they were the organisers.

Scout Patrols and Troops sprang up in Ireland almost as soon as they did in England and in 1908 Scout Troops were formed in Dublin, Dundalk and Wicklow, some of these early Troops are still in existence today.

# History of Scouting

## History of Scouting

From the earliest times some Scout Groups included boating in their programmes, and B.P. realised that this was a very useful programme activity. In Ireland the First Sea Scout Troops were registered in 1912. In 1914 the first Sea Scout Regatta was held, consisting of rowing and swimming races.

The oldest Sea Scout Trophy in Ireland - The Wood-Latimer Cup was competed for in that first Regatta and remained the premier trophy in the Sea Scout Annual Rowing Regatta until it was replaced in 2000.

The most prestigious trophy in Sea Scouting is The Fry Cup - this was first presented in 1918 for a Seamanship competition, which also has continued to the present day.

Sea Scouts also participate in the Smythe Cup, a camping skills competition started in 1916.



## International

Scouting is an international movement with over 25 million members in over 150 countries. It is the world's largest youth movement. Scouts gather every four years at the World Jamboree, this is where Scouts from all over the world come together to camp and share experiences. Irish Scouts have been at every world Jamboree since the first one in Olympia in 1920.

## Important Dates in Scouting

- 1857** Birth of "BP"
- 1907** Camp at Brownsea Island
- 1908** First Scouts in Ireland
- 1912** First Sea Scouts
- 1916** First Cub Scouts
- 1918** First Rover Scouts
- 1929** Foundation of CBSI
- 1948** Boys Scouts of Ireland formed
- 1976** First Girls join SAI
- 2002** New Sea Scout programme launched

# Scout Law

**1. A Scout is to be trusted.** This is one of the most important facts about a good Scout; you can be trusted to speak the truth and to carry out any job to the best of your ability.

**2. A Scout is loyal.** Loyalty is faithfulness and a form of honour. You will not let people down; they can rely on you. When you become a member of a Watch, your Watch will rely on you and you will rely on them.

**3. A Scout is friendly and Considerate.** There is a lot to being a true friend, it means giving and not only taking, discussing and not arguing, caring for other people and for all living creatures. Being considerate means thinking of others before yourself and offering help before being asked.

**4. A Scout is a brother/sister to all Scouts.** As you grow older you will get more chances to meet other Scouts. You should start by being real friends with the Scouts in your own Troop and other Scouts in your District. This friendship should be regardless of what Troop they belong to, what church they attend, or if they are rich or poor. Perhaps you will get the opportunity to attend a Jamboree and meet Scouts from other Countries – they will speak different languages, some will be different colours from you, but they are all Scouts and therefore your friend. As a Scout you have more the 25 million brother and sisters in more than 150 Countries.



# Scout Law

5. A Scout has courage in all difficulties. You have special responsibility to be courageous because through your Scout training you will learn how to cope with different emergencies. There is also the mental and spiritual courage, the courage to stand by and stand up for what you believe to be right. The courage needed to live by the Scout Promise and Law.

6. A Scout makes good use of his/her time and is careful of possessions and property. Time wasted is time lost forever, but making use of your time means dividing your time so that you live life to the full. If you are one of those people who complain about being bored, now is the time to change, stop and look around you, there always are things to do – you are in control of your life. Be careful not to be selfish, make time for other people.

Being careful of possessions includes other people's as well as your own. Never forget that every material thing around you had to be paid for and made by someone. Its important to realise now that anything destroyed or damaged will effect someone. Think how you would feel to find some of your belongings damaged?

7. A Scout has respect for him/her self and for others.. Self respect for a Scout means living up to the ideals set in the first six Scout Laws, but also you must keep yourself clean, healthy and strong in body and mind. Respect for others springs from respect for yourself; you need to be able to respect yourself before you can respect others. You must respect others for their beliefs, minds, and opinions, you don't have to agree but you must accept their right to those views.





# Bullying

Sometimes Scouts do or say things to other Scouts that they think are fun but it is very easy to go too far.

If the other Scout isn't having fun then this is bullying. Think for yourself how you would feel if it was the other way around, so don't do anything to others that you would not like to have done to yourself.

Some of the activities that are bullying are:-

- Excessive "slagging"
- Name calling to give offence
- Exclusion or isolation
- Being over-physical
- Picking on someone
- Threatening behaviour
- Initiation activities

If you are being bullied, or you think someone in your Troop or Patrol is being bullied you should try to stop it.

Maybe they bullies don't know they are causing hurt and they will be glad to be put right. If they don't listen to you then you should tell someone else and the best person to tell is your Watch Leader or your Skipper.

If anyone says or does anything which makes you feel uncomfortable, you should tell your Scout Leader or someone you trust.

Remember the Scout Law, A Scout is friendly and considerate and a Scout has respect for self and others and bullying is definitely not respectful or considerate.

# Spiritual in Scouting

Scouting is open to anyone willing to make the "Promise", which includes a "Duty to God", Scouts does not identify itself with any one religion. Each member has to get to a state of understanding their own religious beliefs and respecting the beliefs of others.

In Scouts, you will experience Spirituality by being encouraged to: -

- Develop an inner discipline (Self discipline)
- Be involved in group activities (Watches & Troop)

- Help to foster a more tolerant and caring society (Promise & Law)
- Discover the need for Prayer / Worship, both personal and shared

Spirituality is what is within us and relates to our needs other than our physical/material needs. It grows within us as we become aware of the wonders of nature and the need to protect our environment.

It helps us come to a deeper knowledge and understanding of our community and self.

# Scout Motto

The Scout motto is “**Be Prepared**” or “**Bí Ullamh**”, if you go through Scouting and follow these two simple words you will survive all that is thrown at you.

**For example:-** If you go on a hike and it starts raining but you have rain gear then you are prepared and won't get wet!

*If you are in a powerboat and your propeller fouls, but you have a set of oars then you are prepared and you can row home!*

These examples all seem so easy and common-sense to overcome but if you had not come prepared to overcome them, then how difficult could each situation have become: - hypothermia, collision or drowning?



## Irish Marine Emergency Service (IMES)



There are fifty Coast Guard Units around the coast with about 600 volunteers and 65 full time staff.

The men and women of the Coast Guard are responsible for Marine Emergency management including Search and Rescue, Cliff Rescue, Pollution Control, Salvage and Wreck, Safety Awareness and the provision of a Commercial Radio Communications Service.

As well as Rescue vehicles and support boats the Coast Guard operates two Sikorsky S61N SAR helicopters, one each from Shannon and Dublin. It also co-ordinates the activities of the RNLI, the Community Inshore Rescue Services and the two Air Corps SAR helicopters based in Waterford and Finner in Donegal.

All of these activities are coordinated from MRCC (Maritime Rescue Co-ordination Centre) in Dublin.

If you see someone in difficulty at sea you should contact the Coast Guard by dialing 999, or 112 from your mobile phone.



# Structure of Troop

## The Sea Scout Troop

The Sea Scout Troop caters for young people whose ages range from 11 to 17 years old and is led by an adult Sea Scout Leader and Assistant(s). Troops have regular weekly meetings, outdoor activities such as hiking and boating, and work sessions for boats and equipment maintenance.

A Troop is divided into a number of Watches; otherwise it is too big to get things done fairly. The Troop is a way to bring a number of Watches together so that the Sea Scout Leader can support and help as many Watches as possible. One Watch will be "On Duty" each week being responsible for various routine duties of the Troop

## The Sea Scout Watch

The Watch is what makes Scouting happen, it is made up of about 6 to 8 Sea Scouts and is led by a Watch Leader (WL), with an Assistant Watch Leader (AWL). Each Watch has a nautical name, such as Port Watch or Starboard Watch. You, your WL and the other members of your Watch plan together, learn together and work together to make things happen. It's easier for you to be part of a Watch because it is a small unit and every member will have something to do. If you're going on a camp,

the workload is divided fairly across the Watch, for example: - buying food and packing the camping equipment. While on camp the work is also fairly divided, for example: - cooking, washing up, chopping wood, getting water, etc. As you can see the Watch is the ideal unit to get out there and do things.

## The Watch Leader

The Watch Leader (WL) is elected by the Watch or appointed by the Watch Leader council (WLC). The WL is the person who is going to help you through your time as a Sea Scout, if you have any questions or unsure of anything this is the person to ask.

The role of the WL is: -

- Plan and lead Watch meetings and activities.
- Keep the Watch members informed.
- Assign tasks to Watch members in a fair way.
- Represent the Watch at the WLC.
- Train the members of the Watch.



# Structure of Troop

## **The Sea Scout Leader**

The Sea Scout leader is usually called the “skipper” and the assistants may have other nautical names such as Mate or Boatswain.

## **The Watch Leaders Council**

The Watch Leaders of the Troop meet together as the Watch Leaders Council (WLC). If the Troop has only two or three Watches, the Assistant Watch Leaders may also attend. The WLC has the responsibility of running the Troop; planning the programme and organising the activities.

The role of the Sea Scout leader is to provide help and advice.

At the WLC, your WL should represent the views of your Watch. If you want something changed or want to do something new, you should discuss it in your Watch and your WL will bring it up at the WLC.

## **The Sea Scout Den**

The place where the indoor meetings take place is called The Den. The large meeting area is called the “Maindeck”.



# Sea Scout Uniform

The Sea Scout uniform is a symbol of the fraternity of Scouting and the Scouting way of life. These are principles that you can be proud of. Of course the mere wearing of the uniform will not give you these qualities, but the very fact that you wear one should keep you aware of what is expected.

It is a privilege to wear the Sea Scout uniform, but it is also a responsibility. Anything you do while wearing it reflects upon all the Sea Scouts. So it becomes your responsibility to keep your uniform correct, clean and cared for, with badges correctly and firmly sewn on.

Sea Scouts wear a navy-blue jersey with **SEA SCOUTS** or **GASOGA MARA** embroidered across the chest. Below the embroidered letters, the Membership Badge is worn on the left and the “World” Badge on the right. The “Ireland” badge (optional) is worn above the letters on the right, and the Charge Certificate Badge(s), on the left.

The Scout belt is worn outside the jersey, and carries a clasp knife on the left and a whistle on the right. A white lanyard is worn around the neck and is attached to the knife at the belt. Trousers are navy blue. Socks and shoes are black.

The Sea Scout cap (Troop optional) has a white top and no peak. A “tally band” is worn around the brim lettered **SEA SCOUTS** or **GASOGA MARA**. The tally band is tied with a bow on the left side, or sewn at the back and left as two “tails”, depending on Troop custom.

## Informal wear

When semi-formality is desirable but full uniform may not be appropriate, uniform T-shirts or “Sweat shirts” are often used. Many Troops have their own for wear at regattas, camps, and other activities. These may be worn with a neckerchief.

### TIP



When outdoors on activities wear your neckerchief. It will help to keep the sun off your neck

# Sea Scout Uniform

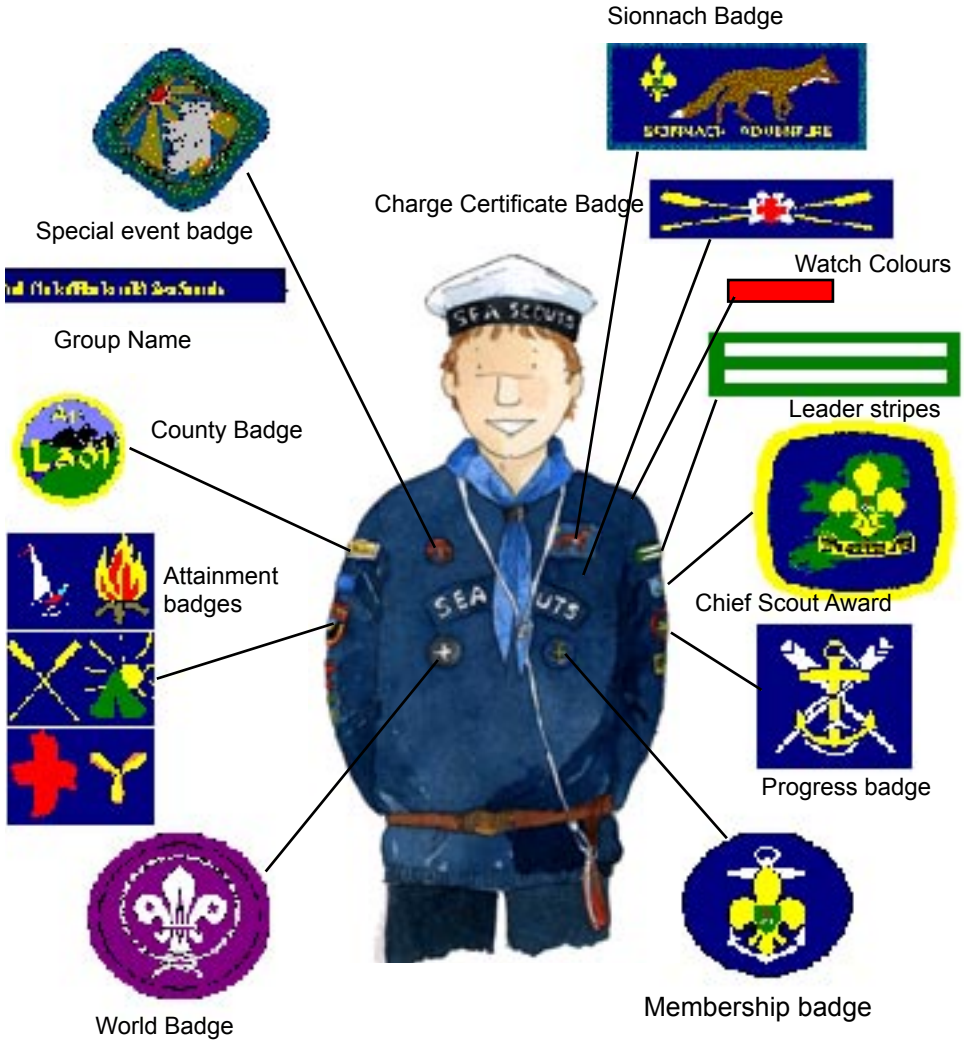

# Drill

Scouting is an active outdoor movement but there are times when some formality and ceremony is used. Ceremonies usually involve some simple drill, and the orders will be given by the Skipper or another Leader. Most Sea Scout meetings and events (eg. Regattas, competitions, prize givings etc.) will start with “Fall In” and finish with “Dismiss”. Not all ceremonies are the same in every Troop, and the traditions of your Troop may be slightly different to the descriptions given below.

## The Drill

### At Ease

Standing up straight, hands held behind your lower back and feet slightly apart.

### Alert

Standing up straight, hands down by your sides, and feet together. You should be facing forward and quietly waiting for the next instruction. To move from At Ease to Alert you move the left foot.

### Right turn or Left turn

Standing at alert at the command turn smoothly ninety degrees to the left or right and finish standing at Alert.

### About Turn

Standing at alert at the command turn smoothly one hundred and eighty degrees to the right (to face the opposite direction) and finish up at Alert.

### Fall In

Gather together with your Watch in line, standing At Ease. Wait quietly for the next instruction.

### Dismiss

Usually given at the end of a meeting or gathering. Standing at “Alert” at the command, turn right, salute and

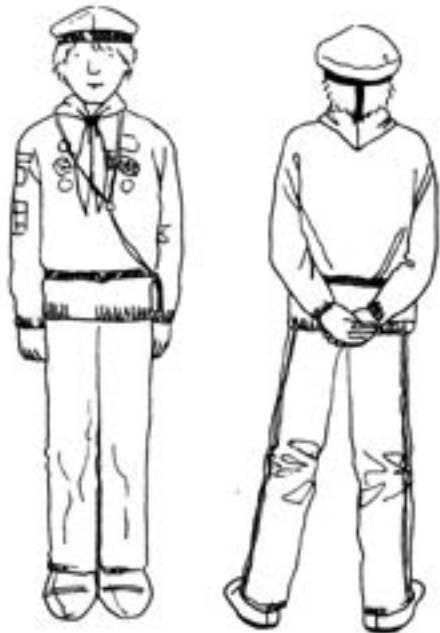

# Sign, Salute & Handshake

## The Scout Sign and Salute

The Scout sign and salute is made standing at attention and by using the right hand. The sign and salute are common to Scouting movements all over the world. The three fingers represent the three parts of the Promise – remember we promised to do our best to:

1. Do our duty to God and our Country.
2. To help other people
3. To keep the Scout Law.

In the salute the tips of the three fingers are brought smartly to the right temple (in front of the ear). When making the sign the hand is only brought up to about shoulder height. The sign is always used during investiture and at any other time the Promise is repeated.



## The Scout Handshake

Scouts throughout the world shake hands with their left hand, this handshake is a sign of trust, introduced by our founder "BP". The story is that an African Chief once greeted "BP" by the use of the left handshake: -



This African Chief held his spear in his right hand and his shield in his left hand, when he greeted someone, he would put down his shield and shake hands with the left hand. This showed trust.

So when Scouts shake hands with their left hand they also are trusting that the other people are not going to attack them. It is only through trust that friendships can grow.





# Investiture

One of the most important ceremonies in Scouting is the Investiture Ceremony, where new Scouts first make the Scout Promise. When you have completed the training for the Membership Badge, arrangements will be made for your investiture. Each Troop has its own traditions for this ceremony, and may include all or most of the following.

The Troop “Falls in”, often in “horse-shoe” formation, with the WLs in front of their Watches, and the Leaders at the open end of the horseshoe. The Skipper calls the Troop to “Alert” and a colour party (flag bearer and 2 escorts) march in with the Troop flag.

Your WL will bring you, and other new Scouts in your Watch, forward to the Skipper, who will formally ask if you wish to become a Scout and if you are ready to make the Scout Promise. When you answer yes, the flag will be lowered in front of you, on which you put your left hand and make the Scout Sign with the right hand. Repeat the Scout Promise after the Skipper. If you have been in the Cub Scouts, you will already have your Group scarf; if not it will be presented to you now, together with your first set of badges. The Skipper will shake hands with you and welcome you as a Sea Scout to the Worldwide Association of Scouting. You salute the Skipper, about turn and return to your Watch.





# Nautical Traditions

## Boatswain's Call

The Boatswain's Call is a whistle used for passing orders on ships. Some Troops use it regularly to maintain maritime tradition. There are 2 notes - low and high. The low note is the **ordinary** note obtained by blowing the call with the **hand open** and the high note is obtained by closing the fingers around the "buoy" but not too tightly.

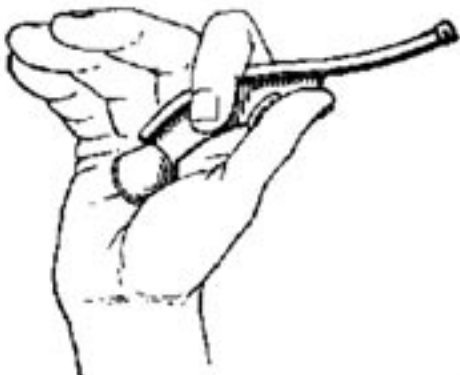

The "call" is the name of the instrument and a "pipe" is the sound it makes. The following pipes are the main ones likely to be used in Sea Scouting:-

**"Stand by"** - a warning, followed by a verbal order - e.g. *"Troop, fall in"*

**"The Still"** - to obtain silence, to stop activity temporarily or as the flag is raised or lowered.

**"Carry on"** - may follow the "Still" or the "Stand by", meaning resume normal activity.

**"The Side"** - formal salute, welcoming an important visitor "on board".

## Ship's Time

The traditional method of indicating time on a ship is by the sounding of a bell. The day is divided into seven watches of four hours each, except the two "dog watches" which are two hours each. This is to give an uneven number of watches so that the crew is on at different times each day.

Middle watch	0000 - 0400
Morning watch	0400 - 0800
Forenoon watch	0800 - 1200
Afternoon watch	1200 - 1600
First dog watch	1600 - 1800
Second dog watch	1800 - 2000
First watch	2000 - 2400



# Nautical Traditions

## Lead Line

This is a long line with a lead weight on the end, used for centuries to measure the depth of water. The “hand lead-line” measured depths to 20 fathoms (1 Fathom = 6 feet) and was marked at 2, 3, 5, 7, 10, 13, 15, 17 and 20 fathoms.

Materials such as leather strips, pieces of white duck, red bunting, blue serge etc. were used as marks, the different materials being easy to identify in the dark by feel. The marked fathoms were called “marks” and the intervening fathoms “deeps”.

A boat’s lead line usually measured about 3 fathoms and was marked in feet and fathoms by knots. If you have a leadline in your troop it will probably be about 5 to 6 meters long, marked with knots. When using a lead line in a moving boat, remember to swing the line and throw it ahead of the boat so that the weight is on the bottom when the line is vertical. You can easily tell from the feel of the line when it is on the bottom. Note the depth from the marks on the line. If the water is shallow enough, an easy way to find the depth is to use an oar.

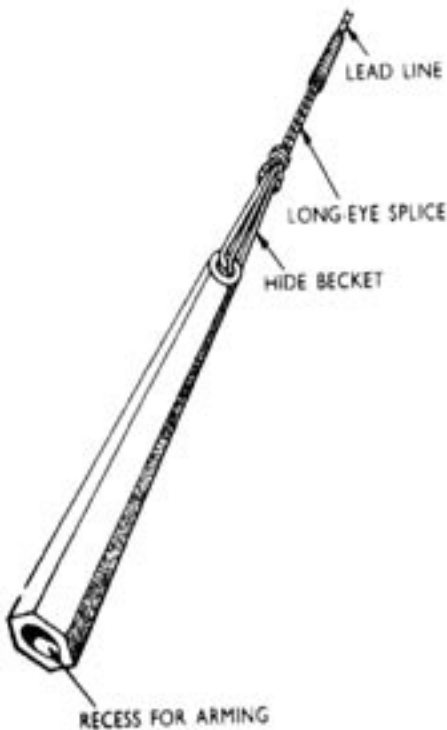

# Flags

We should be proud of our National Flag and treat it with respect as the symbol of our Country. We must also show the same respect to the flags of other Countries.



IRISH FLAG

A National Flag at sea is called an Ensign. In some Countries the Ensign may be different to the National Flag. The Ensign of Ireland is the Tricolour, the same as the National Flag on land. A special Ensign may be flown in place of the National Flag - both should not be flown together in the same vessel. You may use the Scout special ensign on a flag mast, but it should never be carried in a parade.

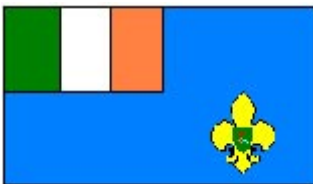

SPECIAL ENSIGN



## TIP

*Before raising or lowering, check the flag and the halyards.*

In a nautical flag mast with a “gaff”, the place of honour is the peak of the gaff and not the masthead. The Ensign is always flown from the peak of the gaff. The Scout Pennant is flown from the masthead. Other flags, such as the Sea Scout flag, a troop flag or the pennant of the Duty Watch, may be flown from the horizontal yardarm, the “starboard” yardarm taking precedence over the “port” yardarm.

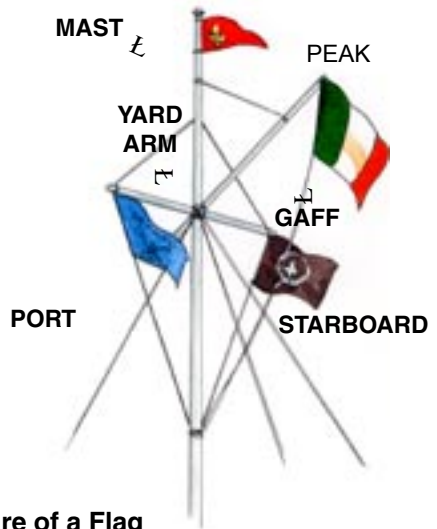

## Care of a Flag

A flag should not be allowed to touch the ground, trail in water or become entangled in trees or other obstacles. When not in use, the flag should be folded and put away. The usual method is to fold it into a reasonable small rectangle and then roll it up. Some Troops may fold the flag into quarters and then fold it into a small triangle.

# Flags

## Hoisting the National Flag

When the flag is being raised or lowered, Scouts in uniform should come to alert and salute. If Scouts are present and formally “Fell In”, they should be brought to alert and only the Leaders should salute.

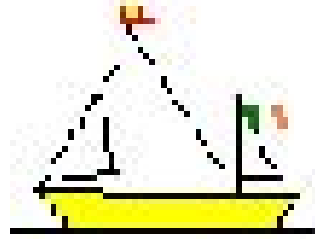

## The National Flag Ensign should:

1. Be flown in the open only between sunrise and sunset.
2. Be hoisted free and never “broken” from mast head.
3. When hoisting it should be raised quickly, but smoothly, to the mast-head (ordinary flagpole) or the peak of the gaff (nautical flag mast), and the top corner of the hoist should be close up.
4. It should be lowered slowly and smoothly.

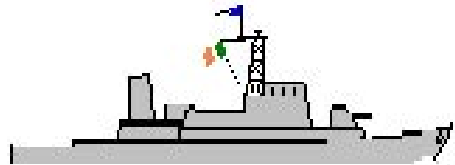
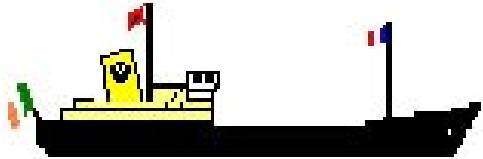

## Half Mast

The flag is flown at halfmast as a sign of respect for the dead. It is first hoisted close-up and then lowered slowly to the half mast position. In the evening, the flag should be hoisted close-up before being lowered completely.

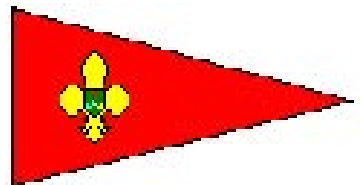
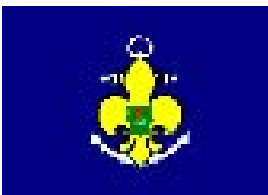
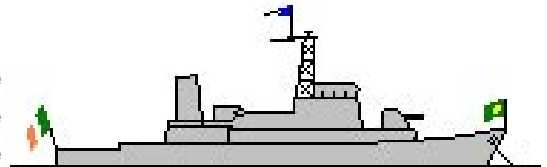

# Flags

When afloat, the Ensign should be flown from the Ensign Staff astern, which is the place of honour. Sometimes a large Ensign is worn at the Ensign staff when the vessel is anchored or moored, and is replaced by a smaller Ensign at the peak of the gaff when under way. A vessel under sail may wear the Ensign at the peak of the gaff (mizzen gaff if more than one mast). If the vessel is Bermuda rigged, the Ensign may be flown from a point two thirds way up the leach of the sail, from the backstay or the Ensign staff.

## Pennant

Boats in Scout use should fly the Scout Pennant from the masthead. A Troop or association flag may be flown from a yard arm in a single masted vessel or from the mizzen masthead in a ketch or yawl.

## Courtesy Flag

When visiting a foreign port a ship usually fly the flag of the country being visited at the foremasthead, or from the starboard yardarm. This is called a courtesy flag.

## House Flag

In merchant ships, the House Flag (Company flag) is usually flown from the main masthead.

## Naval Vessels

Naval vessels in commission fly a long, narrow "Commissioning Pennant" from the masthead, and when at anchor or moored, a "Jack" from the jackstaff in the bow. The Irish Naval Jack is green with a gold harp.

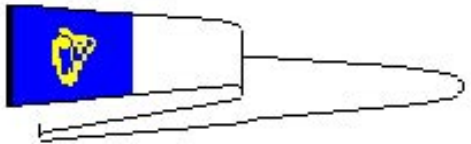

## Flag up and flag down

Meetings and events may start and finish with a simple flag break ceremony. The Troop is called to "Alert" by the Skipper, who then gives the order "Colours". The Duty WL steps forward and hoists the Ensign. The Leaders salute as the flag is raised. The Duty WL secures the halyard, takes a step back, salutes the flag and returns to position. If other flags are used in addition to the Ensign (eg. Scout pennant, Troop flag or Duty Watch pennant) they should be hoisted together by other members of the Duty Watch.

For flag down, the reverse of the above happens, except that the person lowering the flag, after securing the halyard, returns to position without saluting.

# Rope Work

There are thousands of individual knots but you only need to know a few.

**All knotting may be summed up under three headings:-**

- **A Hitch** - Hitches are knots that fix a piece of rope onto something else.
- **A Bend** - Bends are knots that join two pieces of rope together.
- A knot is anything other than a bend or hitch



## Reef Knot

**Uses:-** The Reef Knot is a flat knot. Do not use it for joining ropes together, as it is not always safe, particularly with nylon, terylene or other “man-made” ropes. Tying the reef points of a sail, for first aid and for tying string on parcels.



Reef Knot



SHEET BEND

## Sheet Bend

The sheet bend is normally used to join two ropes together.

**Uses:-** for tying flags onto halyards where there are no clips in place.

## Double Sheet Bend

The double sheet bend is more secure than the sheet bend, and is used where the ropes are slippery, of different materials, or of unequal thickness.

**Uses:-** tying flags onto halyards.

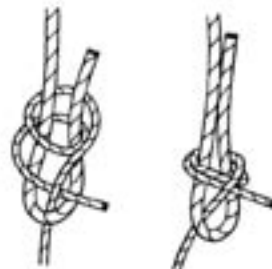

DOUBLE SHEET BEND

# Rope Work



Round Turn and Two Half Hitches

## Round Turn and Two Half Hitches

This is a strong and secure knot. It is used to tie a rope to a post or ring.

**Uses:-** Secure a boat or tow a vehicle.



Fisherman's Bend

## Fisherman's Bend

The fisherman's bend is similar to the round turn and two half hitches, but the first half hitch passes through the round turn. The knot is never pulled tight and can be untied easily.

**Uses:-** to attach an anchor line to the ring of the anchor.

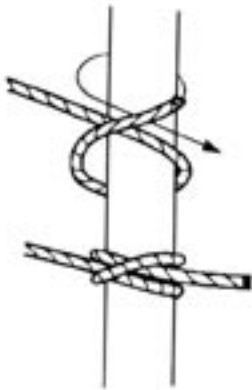

Clove Hitch

## Clove Hitch

The clove hitch is a simple knot for tying a rope to a post, and may be used in the middle of a line as well as at the end. A clove hitch remains secure if it is kept under a steady strain, but if the strain is intermittent, it may come loose, and untie.

**Uses:-** secure a light boat to a bollard or suspend objects.

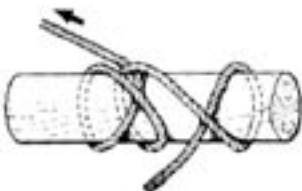

Rolling Hitch

## Rolling Hitch

A rolling hitch is used to tie a rope to a spar, when the pull is in the line of the spar.



# Rope Work

## Timber Hitch

The timber hitch is a simple way of putting a constricting piece of rope onto a spar or similar

**Uses:-** in the start of lashings.



Timber Hitch

## Bowline

The bowline is used for making an eye or loop in the end of a rope or mooring a bowline. It does not loosen or jam.

**Uses:-** on a mooring line to slip over a bollard, for attaching jib sheets to the clew of the jib, for rescue a when tied around the waist, etc.



Bowline

## Bowline on the Bight

The bowline on the bight puts two loops in the end of a rope.

**Uses:-** used like a chair to lower a casualty with one loop under the arms and the second loop under the knees.

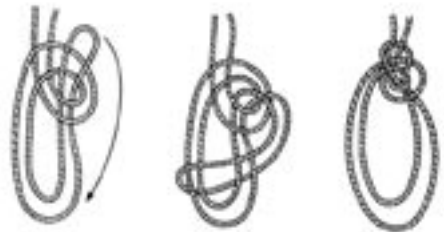

Bowline on a Bight

## Overhand knot

A simple overhand knot may suffice to stop the end of a rope running through a block or cleat.



Overhand Knot

## Figure of Eight

Is a knot on the end of a rope to stop it running through a fairlead or pulley and is more easily untied.

**Uses:-** Ends of jib leads and main sheets.

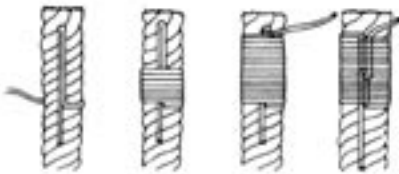

Figure of Eight

# Rope Work



Sail Makers Whipping



Common Whipping

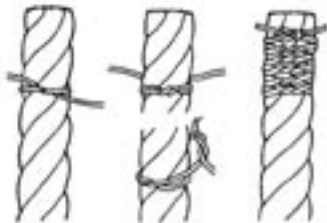

West County Whipping



Eye Splice



Back Splice

## Whipping

This is used to protect and prevent rope ends from unravelling.

## Sail Makers Whipping

The sail makers whipping is one of the most reliable ways of whipping the end of a three strand rope to stop it unravelling.

## Common Whipping

A simpler type is the common whipping. There are a number of version and the one shown is probably the commonest.

## West Country Whipping

The West Country whipping is a series of overhand knots tied on the opposite sides to each other.

## Eye Splice

When you want to fix a piece of rope permanently such as the bowline on a boat it is best to splice it in place. The best splice for this is the three-stranded eye splice.

## Back Splice

The most common splice that one sees is the back splice but it has limited use. As a back splice doubles the diameter of the rope it can no longer be roved through a block or pulley. A whipping is a better way to protect a rope end.

# Pioneering

Once you've mastered your basic rope work skills, you can move on to Pioneering. Pioneering uses ropes and spars to build tables, dressers, gateways, towers and many other things. Before you start you will need to learn a few more knots called lashings. Once you learn these then your imagination is your only limit.

## The Square Lashing

This is used for securing one spar to another, when they cross each other, at any angle. Start with a clove hitch around the bottom or most secure spar. Do 3 or 4 complete turns under and over each spar. Pull each turn as tight as possible.

The lashing is passed around between spars frapping over the first turns several times and pulled tightly to draw the whole thing firmly together. Finish off with two half hitches

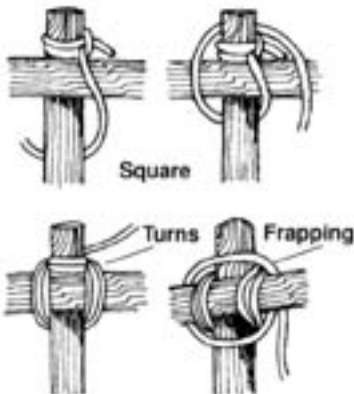

## Figure of eight Lashing

Used to make a tripod, lay three spars alongside each other, with the two outside spars running one way and the centre one the opposite direction.

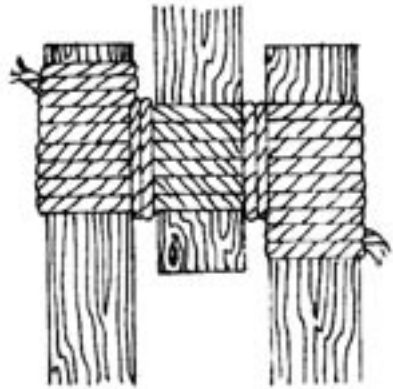

Start with a clove hitch around one of the outside spars, and give six or eight turns around the spars working under and over alternately like a figure of eight. "Frap" between each spar, and finish with two half hitches. As the legs of the Tripod are opened out, the lashing automatically tightens so you have to leave a certain amount of slack in the lashing from the beginning in order to be able to open out the legs.



### TIP

*To ensure stability of any pioneering gadget, build triangles into the design.*

# Pioneering

## Diagonal Lashing

Used to lash together two spars which from their position tend to spring apart. Begin with a timber hitch round both spars, drawing them together, then take three or four turns around each fork, follow with three frapping turns between the two spars and finish with a clove hitch on one of the spars.



### TIP

*Make sure all pioneering projects are properly secured with guy ropes when necessary.*

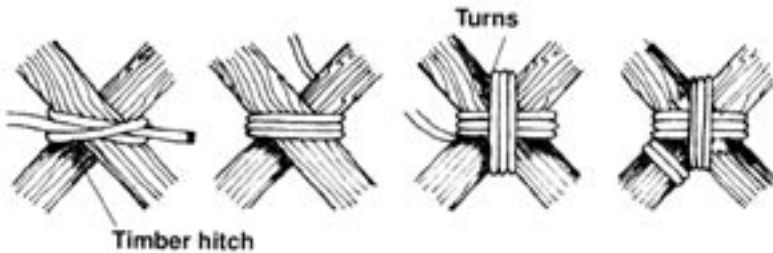

## Sheer Leg Lashing

This lashing is used to lash two spars which will open slightly to form sheer legs. Start off with a clove hitch around one of the spars. Make seven or eight turns around both spars, then several frapping turns between them and finish off with two half hitches around one of the spars. This lashing will tighten further when the two spars are pulled apart to form the sheer legs.

## Sheer Lashing

If you want to add to the length of a spar (to make a flagpole), two sheer lashings are used without frapping turns.

These lashings have to be very tight and the initial clove hitch is put around both spars, as is the two half hitches used to finish off the lashing. The lashing can be tightened further by driving wooden wedges down between the two spars, tent pegs are ideal for this.



# Pioneering Projects



# Pioneering Projects





# Heaving A Line

Heaving a line is a method of throwing a line from one location to another. The most common use of a heaving line is at sea, to pull a cable to shore from a ship. It may also be used to rescue a person from the water.

You need to be able to heave a line a reasonable distance accurately, it is also important to do this from a boat as well as from land.

To make it easier to throw you may need to add / put a weight on the end of the line; this weight is usually a "Monkey's Fist".

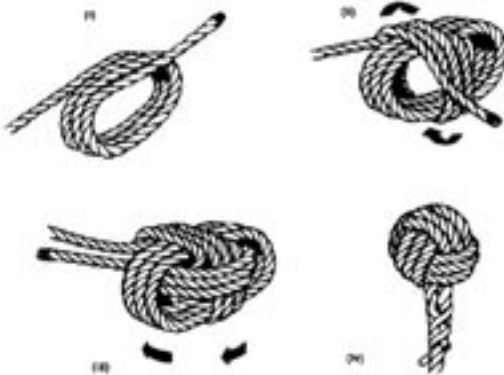

The line should be of such length and size to reach your target but not be too heavy to lift when fully coiled.

## TIP



*Take time to coil the line properly and always leave a line coiled ready for use.*

**The main points to heaving a line are:-**

- Coil the line clockwise from the fixed end
- When coiling avoid overlap
- Secure the fixed end
- Split the coil into half
- Hold the coils as shown
- Point in the direction of throwing
- Throw the line underhand

**Things not to do: -**

Do not force the rope into a coil let it flow with the natural twist in the rope.



**Secure the end**

**Holding the coils**

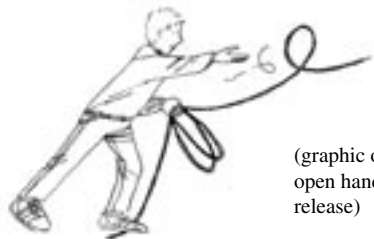

(graphic of open hand to release)

**Heaving the line**



# First Aid

First aid is the immediate treatment given to a patient for any injury before the arrival of an ambulance, doctor or other qualified medical person.

## **The aims of first aid: -**

To preserve life.

To prevent further injury (including to yourself).

To limit worsening of the condition.

To promote recovery.

The three “P” - PRESERVE, PREVENT AND PROMOTE

## **Responsibilities of the First Aider:**

-

Assess the situation

Assess the patient

Make a diagnosis

Provide treatment

Quickly ensure medical help has been summoned

Remain with the patient and re-assure

## **The Primary Survey**

The purpose is to identify and treat all life threatening injuries and/or conditions in order of priority.

This survey is known as the “**A,S, B, C**”

**Airway** - Open and clear

**Spine** - Possibility of spinal injury?

**Breathing** - Breathing present?

**Circulation** - Pulse Present?

- Major Bleeding?

Examine any other serious injuries?

Identification cards, medical alerts, etc?

## **The Secondary Survey**

Systematic “Head to Toe” examination of a patient: - Head, Neck, Shoulders, Chest, Abdomen, Pelvis/lower back, Lower limbs, Upper limbs

## **Monitor Vital Signs: -**

Breathing - Rate, depth, quality

Pulse - Rate, rhythm, strength

# First Aid

## Life Threatening Conditions

- Cardiac Arrest - Heart stopped
- Asphyxia - Not able to breathe
- Bleeding
- Shock

## Making a Diagnosis: -

History and how the injury happened

## Symptoms

- What the patient feels or tells you  
e.g. "My arm hurts, I feel sick"

## Signs

- What you see, feel, smell or hear

## Emergency Services

Dial 999 or 112 (European Emergency number) and ask for the appropriate service.

Always give the following information:

Your name and telephone number

Exact location

Type and seriousness of the incident

Number of patients and conditions.

Any other hazards

Any directions or/and land marks to guide the emergency services

NEVER HANG UP FIRST



## First Aid Kits

Should be kept small, yet still have the necessary items, but even these are of little use unless you know some thing about basic first aid. Suggested content for a personal first aid kit:-

- Assorted plasters (12)
- Triangular bandages (2)
- Safety pins (2)
- Sterile dressing (medium)
- Sterile dressing (large)
- Sterile wipes (8)
- Scissors and tweezers
- Steri strip sutures
- Crepe bandage
- Pencil & accident report card
- Pair of disposable latex gloves
- Optional extras
  - Lip salve
  - Sun block
  - Insect repellent

## Bleeding

Blood loss can lead to shock or ultimately death. Bleeding can be internal or external. Internal bleeding will quickly result in the signs of shock and should be treated for this condition. External bleeding is usually obvious after an examination.

## Types of external bleeding

Arterial - spurts from the wound

- Bright red in colour

Venous - Flows from the wound

- Dark red in colour

Capillary - Oozes from the wound

- Usually minor wound

# First Aid

## Cuts and Scratches

When the skin is broken blood can escape and infection can get in. Try to keep the wound clean, wash with running water or use an antiseptic wipe. When the wound is clean and dry cover with a sticky plaster to keep any infection out.

## Nose Bleeds

You need to protect the airway from the inhalation of blood and control bleeding.

Sit the casualty down with their head forward and get the casualty to pinch their nose just below the bridge and to breath through their mouth.

Tell them not to speak, swallow, cough, spit or sniff, as they may disturb blood clots.



After twelve minutes, ask the casualty to release the pressure. If their nose is still bleeding, reapply the pressure for a further twelve minutes.

If the nose bleed continues after this time send the casualty to hospital. Once the bleeding is stopped and with the casualty leaning forward, gently clean around their nose and mouth with luke-warm water.

Tell the casualty to rest quietly for a few hours and to avoid exertion and not to blow their nose, as this will disturb any blood clot.

## Animal Bites

*Bites from sharp, pointed teeth cause deep puncture wounds, which can carry infection.*

### For Serious bites: -

1. Control the bleeding by applying direct pressure and raising the injured part.
2. Cover the wound with a sterile dressing or clean pad bandaged in place.
3. Get the casualty to hospital.

### For Superficial bites: -

1. Wash the wound thoroughly with soap and warm water.
2. Pat the wound dry with clean gauze swabs and cover with an adhesive dressing or a small sterile dressing.
3. Get the casualty to see a doctor in

# First Aid

## **Insect Stings**

Bee or wasp stings can usually be painful. There is usually an initial sharp pain followed by mild swelling. Further problems may occur when people are allergic to stings or if they get stung in the mouth or throat, as swelling can occur and obstruct the airway.

1. If the sting is still in the wound, take it out using tweezers.
2. Apply cold compress to relieve pain and reduce swelling.

## **Jelly Fish Stings**

*Jellyfish can cause painful stings.*

1. Reassure the casualty and sit them down. Pour large amounts of vinegar or salt water over the injury to incapacitate stinging cells not activated.
2. Dust a powder around the sting; to make any remaining stinging cells stick together.
3. Gently brush off the powder with a clean, non-fluffy pad.

## **Shock**

Shock is the failure of the circulation system to adequately supply the cells of the body with oxygen.

### **Causes of Shock**

Blood loss

Heart Failure

Allergic reaction

Loss of body fluids – burns, vomiting, diarrhoea

### **Signs and Symptoms of Shock**

Rapid Pulse

Pale Skin

Cold clammy skin

As shock progresses

Falling level of response

### **Weakness**

Rapid/shallow breathing

Restlessness

Thirst

### **Treatment of shock**

Ensure “A, S, B, C”

Treat the cause - Raise lower limbs if possible

- Monitor vital signs
- Prevent chilling
- Treat any other injuries
- Calm and reassure
- Loosen tight clothing
- Do not give anything to eat or drink
- Do not leave the patient alone

Urgent removal to hospital if no clear recovery

# First Aid

## Recovery Position

Unconscious casualties who are breathing on their own should be placed into the Recovery Position. This is a natural rest position for the body and prevents the tongue falling back and blocking the airway, it also reduces the risk of the stomach contents being inhaled into the lungs.

1. Remove anything that will get in the way, e.g. glasses, bulky objects in pockets, false teeth etc.
2. Loosen any tight clothing.
3. Place the casualty on their back, with their arms down by their sides, legs straight and together.
4. Kneel beside the casualty; open the airway by tilting the head and lifting the chin.
5. Place the arm nearest to you at right angles to the casualty's body, elbow bent with the hand, palm up.
6. Bring their far arm across the chest and hold the back of the hand against the casualty's nearest cheek.
7. With your other hand grasp the far leg just above the knee and pull it up, keeping the foot on the ground.
8. Keep the casualty's hand pressed against their cheek, pull on the leg to roll the casualty towards you onto their side.
9. Adjust the upper leg so that both the hip and knee are bent at right angles.
10. Tilt the head back to make sure the airway remains open.
11. Check the pulse and breathing regularly.



# First Aid

## Hypothermia

Our bodies try to keep a constant temperature of 37 degrees C. If we get too hot the skin becomes flushed and we start to sweat, causing heat loss and cooling respectively. If we get too cold the body reduces circulation to the extremities such as the fingers, arms, toes, feet and ears in an effort to ensure our vital organs are kept at 37 degrees. If our core temperature drops much below this we are into hypothermia. Hypothermia (exposure) is caused by a combination of exhaustion and severe chilling of the body surface, resulting in the lowering of the body's core temperature.

## Signs and Symptoms of hypothermia

There are many signs which may indicate that one of your party is beginning to suffer from hypothermia:

- complaints of cold, tiredness, cramp or unusual or erratic behaviour
- mental and physical drowsiness
- slurring of the speech
- irrational or violent behaviour
- disinterested
- problems focusing, stumbling or uncoordinated movements
- collapse or coma; at this stage the victim is in a very serious condition.

## Treatment

Treatment should aim to eliminate the causes of and prevent further heat loss.

- Stop and shelter

- Insulate the casualty with extra clothing or sleeping bag, cover their head.
- Give them a warm sweet drink, food etc.

## CAUSES

**Wind chill** - At any temperature the cooling effect of the wind on the body increases with wind speed. It is therefore likely to feel much colder in the mountains on the sea or large lake.

**Exhaustion** - This is caused by attempting too much or by not eating enough to replace used energy. Plan your activity to suit the abilities of the group. At sea, simple problems can arise due to sea sickness.

## Exposure

**Wet cold** - Wet clothing has greatly reduced insulation properties in certain fabrics. Avoid getting wet by sensible use of your wet weather gear. Use the layered system of clothing. Wear the correct water activity gear.

**Injury or illness** - Often hypothermia results when the group is unexpectedly delayed. If an accident does occur make sure you keep warm, provide shelter using your tent, group shelter or bivvy bags and make a hot brew. If sailing, the sails can be used to make a shelter or just get down into the boat.

**Activity Planning** - Overestimating the fitness of the group and underestimating the time are common mistakes made by activity planners.

# First Aid

## Minor Burns and Scalds

- Flood the injured part with cold water for at least 10 minutes to stop the burning and relieve the pain. If water is unavailable use any harmless cool liquid, such as milk or drinks will do.
- Gently remove any jewellery, watches, belts or constricting clothing from the injured area before it begins to swell.
- Cover the area with a sterile dressing or any clean, non-fluffy material and bandage loosely in place. A plastic bag makes a good temporary covering.

**Do Not** break blisters or interfere with the injured area.

**Do Not** apply adhesive dressing to the skin, the burn maybe more extensive.

**Do Not** apply lotions, ointments or fats to the injury; they can further damage the tissues and increase the risk of infection.

## Sunburn

This is caused by an over-exposure to the sun. Sunburn can even occur on an overcast summers day in high altitudes from “sky-shine” or reflection from winter snow. It can also occur on open water were the suns rays are reflected back.

Get the casualty under cover, into shade or cover in light clothing or towel.

Treat as for other burns and scalds.

## Fainting

This is the temporary reduction of blood flow to the brain.

Causes or Recognition

- Reaction to pain or fright
- Brief loss of consciousness
- Emotional upset
- Sudden fall to the floor
- Exhaustion
- Slow pulse
- Lack of food
- Pallor
- Long periods of standing

- Ensure A,S, B, C
- Raise lower limbs, if seated place head between knees (impending faint). Ensure plenty of fresh air and loosen tight clothing
- Reassurance and treat any injuries
- If unconsciousness persists call for an ambulance

## Blisters

Thin “bubbles”, known as blisters, form on skin that has been damaged by heat or friction. During healing, new skin forms at the base of the blister; and the other layer of dead skin will eventually peel off.

A blister usually needs no treatment but:-

- Never break a blister as you may introduce infection.
- If it breaks or is likely to be damaged, cover the injured area with dry, non-adhesive dressing that extends well beyond the edges of the blister. Leave in place until the



# First Aid

## Asthma

This is a distressing condition in which the muscles of the air passages go into spasm and the linings of the airways swell. This results in the narrowing of the airways making it difficult to breathe.

An asthmatic attack may be caused by:

- an allergy, a cold, a particular drug or cigarette smoke. At other times no obvious trigger can be identified. Many suffers are prone to attacks at night.

The drugs in inhalers open the air passages, easing breathing, there are two main types of inhalers: -

“Reliving Inhalers” – Blue caps used to ease an asthmatic attack

“Preventive Inhalers” – Brown or White caps, used to prevent an attack.

### Signs:

1. Difficulty with breathing, long breathing out time.
2. Wheezing.
3. Distress and anxiety
4. Difficulty in speaking
5. Gray blue skin
6. Dry, tickly cough

Keep calm and reassure the casualty. Let the patient take a “Reliever Inhaler”, which usually works within a few minutes. Position the casualty upright, leaning forward and get the casualty to breathe slowly and deeply.

Ensure a good air supply

If the attack eases within 5 to 10 minutes, get the casualty to take another dose from the inhaler.

### If the attack is getting severe and

- The inhaler has had no effect after 5 to 10 minutes
- The casualty is getting worse
- Breathlessness is making talking difficult
- The casualty is getting exhausted.

Dial 999 or 112 for an ambulance. Help the casualty to continue taking the inhaler every 10 minutes until medical help arrives.

# First Aid

## Choking

Choking is when something is stuck at the back of the throat, which may either block the throat or induce muscular spasm. Choking requires quick action from the first Aider, be prepared to resuscitate if the casualty stops breathing. If the airway is only partial blocked and the casualty is still able to speak or breathe, do not carry out any rescue treatment, as it may worsen the condition. But call for help and encourage the casualty to cough up the blockage.

### Signs of choking:

Initially congested face.

Later grey-blue skin colour.

Distressed signs from the casualty, who may point to the throat or grasp the neck.

### Treatment:

Ask the casualty to cough. If they cannot cough up the object perform abdominal thrusts.

### Abdominal Thrusts:

Put your arms around their trunk from behind. Make a fist with one hand below the ribcage, thumb side against abdomen, and then grasp the fist with the other hand.

Pull sharply upwards and inwards. The force against the casualty's diaphragm should help to expel the obstruction. Watch to see if it falls out of their mouth.

Be persistent, continue abdominal thrusts until the obstruction is removed or medical help is available.

## Sprains

A sprain occurs at a joint, when the ligaments and tissues around that particular joint are suddenly torn or wrenched.

A Strain occurs when a muscle or group of muscles is over stretched and possibly torn.

1. Rest the injured part
2. Apply ice or a cold compress
3. Compress the injury
4. Elevate the injured part



# Artificial Respiration

## Artificial Respiration

One of the most important skills you can learn is Artificial Respiration (AR) and Cardio Pulmonary Resuscitation (CPR).

It is the most important of skills because it gives you the ability to save a life.

Only by practice and training will you master the skill and have the confidence to implement it should you come across a situation that requires it.

The most common reason people stop breathing is due to suffocation in water, after an electric shock or after a Road Traffic Accident.

Should you come across a casualty whom you suspect is not breathing you must:-

- **Send for help immediately and**
- **Start AR as soon as possible**



### TIP

#### ***Foggy says: -***

- *Stay Calm*
- *Send for help*
- *Assess the situation*
- *Act*

Lie the casualty on their back

Check to see if the casualty is breathing (check if chest is rising or see if you can feel air coming out of their mouth)

Open the air way

Check there are no blockages in the mouth (chewing gum, seaweed, dentures etc).

Rest one hand on the forehead and pinch the nose between your fore finger and thumb.



With the other hand cupped around the chin open the patients mouth

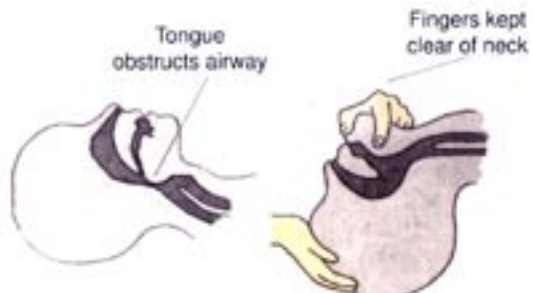

# Artificial Respiration



With your mouth make a seal around the casualty's mouth and blow a full breath.

Turn your head to the side to check if the chest rises and falls. If it doesn't the airway is still blocked.

Continue with breaths at the rate of one every 5 seconds until the casualty breathes by themselves or you are relieved by medical personnel.

Place the casualty in the recovery position.



Every year in March the National First Aid and National Artificial Respiration competitions take place. They give you a chance to see how well you know your stuff in a simulated emergency. Ask your Skipper for details.



## TIP

*You should endeavour to complete the Royal Life Saving Society's or the National Safety Associations CPR courses or a first aid course by one of the first Aid Organisations*

# Swimming

It is very important if you are going to be involved in water activities to be confident in the water. If you cannot swim, it is never too late to learn, get someone to teach you.

You should practice swimming in normal boating gear, which includes wearing a lifejacket or buoyancy aid. You may be surprised at how difficult it is to swim with one on.

In Sea Scouting swimming is included as a basic safety factor, not just as a fun activity. You should be able to swim in the waters where your Troop normally does its activities. It does not matter which swimming stroke you use, so long as you can manage it sufficiently. Also, practice survival skills such as floating or treading water.

**Do not** swim for at least an hour after a meal

**Do not** dive into unknown waters

**Do not** swim in dangerous areas

**Do not** swim where there are strong currents or tides

**Do not** mess about in the water

**Do not** swim out, always swim along the shore

**Do not** use air beds or similar on the open sea



## TIP

*Being able to swim is fun but always try to improve your swimming ability*

# Swimming



## Buddy System

This is a method of ensuring no one goes missing while swimming in a group. Each person swimming has a partner and each looks out for the other.

At regular intervals the swimming Leader will give a signal to which, each pair will form up and raise their hands, to be counted.



## Rescue

If someone is in trouble, try to reach out with whatever is handy; use something to increase your reach (branch, fishing rod or oar), or throw something that will float (heaving line, throw bag, life buoy or lifejacket)

## Do: -

- Learn to Swim
- Use the “Buddy System”, never swim alone
- Swim well within your capabilities
- Obey any warning notices or danger flags
- If the waters are unknown to you, ask someone who knows



**Red & Yellow flag:** - Lifeguard is on duty

# Lifejackets / Buoyancy Aids

You should use a Buoyancy aid or Lifejacket at all times afloat. They should have the C mark of approval. These are classified by level of buoyancy, measured in units called "Newtons".

1. Buoyancy aids (50 or 100 Newton) sheltered to inshore waters only.
2. Lifejackets (150 or 275 Newton) - Up to offshore waters.

It is important to learn which one is to be worn for each type of activity but your WL or SS will explain this to you.

## Buoyancy aid for General Inshore and Inland waters - 100 Newton

- Suitable for swimmers and non-swimmers
- Will provide good insulation
- If unconscious, you may be left face down in the water
- Retro-reflect strips

## Lifejackets for Coastal waters - 150 Newton

- Suitable for swimmers and non-swimmers
- Permanent buoyancy and can be inflated but then difficult to move around
- Will keep you face up in the water
- Whistle
- Retro-reflect strips



LIFEJACKET

## Putting on a Lifejacket / Buoyancy aid:-

- Follow the instructions of the manufacturer.
- Ensure that you have the right type and size for the activity.
- Pull the straps tight to a snug and secure fit.



# Lifejackets / Buoyancy Aids

## Care of a Lifejacket / Buoyancy aid:

### 1. While in Use: -

- Check it before using
- Wear it
- Don't use the whistle unless in distress
- Don't inflate until you are in the water
- The Best way to carry one is to wear it properly

### 2. After use: -

- Rinse in fresh water
- Hang up to dry. Damp jackets lying will develop mildew
- Don't use them as a changing mat or sit on them
- Make sure they are fully deflated
- Check that nothing is missing or damaged

## Regular checking of a Lifejacket or Buoyancy aid

- Check buckles, zips and straps for wear or damage
- Check distress whistle and inflation valve (do they work - test)
- Check that they are clean
- Any defective jacket should be destroyed



BUOYANCY AID



### TIP

*Care for them and they will care for you. Always wear a lifejacket or buoyancy aid when afloat.*

# Safety Afloat

Getting Afloat, whether it be rafting, rowing, sailing, power boating or canoeing is the real fun and adventure part of Sea Scouting. However, it can only remain an enjoyable activity if it is conducted safely. Always follow quickly the instructions of the person in charge of the craft. Your Leader will have a copy of the detailed rules and guidelines for Water Safety in general, and for the different Water Activities. You are not expected to know them all but you must appreciate the importance of the main points.

## Safety Guidelines for Water Activities

### **Be able to swim.**

You should be able to swim in your normal Water activity gear, in the waters normally used by your Troop. Demonstrating swimming ability in heated indoor pool is not sufficient.

### **Wear the correct clothing.**

Dangerous or heavy clothing should not be worn – e.g. waders, heavy boots, etc. See the section on “Clothing to wear for Water Activities”.

### **Wear a lifejacket or buoyancy aid.**

Should be worn at all times in rafts, open boats or canoes. See the section on “Buoyancy Aids & Lifejackets”.

### **Get the weather forecast.**

Never go afloat unless you have the up-to-date forecast. Sea Scouts should normally not go afloat if the winds are above a force 4.

### **Observe good conduct.**

Do not “fool about” in a craft and always follow the instructions of the person in charge.

### **Avoid over loading a craft.**

Always make sure a boat is “trimmed” correctly;

### **The craft must be seaworthy.**

It must be seaworthy, in good condition and have a valid Boat Certificate.

### **Take the correct equipment.**

You should know the correct equipment that is required for the craft you are using and also the spares needed. This will depend on the type of craft and the activity. Always Be Prepared!

### **Know the local tides and currents.**

Always check the times of low and high tides. Avoid areas where the tidal streams are strong. Remember that conditions can change when the tide



# Safety Afloat

**Know the local dangers and hazards.** Find out about the dangers like: - rocks, sandbanks, wrecks, shallows, weirs, locks, etc. Certain conditions of wind and tide particularly in shallow water can cause waves to break dangerously for a small boat and should be avoided.

**Remain alert at all times.** On a water activity, always be aware of what is going on around you.

In a sailing boat watch out for the boom swinging across the boat when tacking or gybing. Look out for the wake of a power boat.

**Charge certificates.** Any person in charge of a boat must hold a charge cert. for the type of boat and the area of water in question.



## HAVE FUN BUT STAY SAFE

A very useful check list to remember in relation to water safety is:-

### “WATCH IT”

- |          |  |
|----------|--|
| <b>W</b> | - Weather - get the latest weather forecast              |
| <b>A</b> | - Area - plan the route and local knowledge              |
| <b>T</b> | - Tides - look them up and note them                     |
| <b>C</b> | - Clothing - adequate, warm and waterproof               |
| <b>H</b> | - Hazards - Places and situations to avoid and beware of |
| <b>I</b> | - Inventory - check list of gear and spares              |
| <b>T</b> | - Tell someone - route, times etc.                       |

# Clothing for Water Activities

Even during the warmest day in the summer, it will be colder when out on the sea, so be prepared. When going on water activities wear layers so if you find yourself too warm, you can take off a layer. Whatever you wear, expect it to get wet, if it doesn't then that's a bonus. Always have a complete change of clothing for when you return. Remember the "wind chill" factor . . . when you are exposed to the wind you may feel colder than if you were sheltered, this factor is increased if you are wet. Being ill prepared can lead to you not enjoying your water activities or even worse to hypothermia.

(See Section on hypothermia-page 40)

## Basic personal clothing to wear

- Swimming costume or togs
- T-Shirt
- Shorts
- Runners (good grip)
- Sweatshirt or Jumper
- Socks
- Gloves
- Tracksuit bottoms
- Waterproof coat & trousers
- Hat



## Personal equipment to bring

- Complete change of clothes
- Towel
- Coat
- Warm drink

## Safety equipment to wear

- Buoyancy aid or lifejacket
- Canoeing:- Helmet & spray-deck



## Optional personal clothing to wear

- Wet suit - when you get wet, a thin layer of water is trapped between the synthetic Neoprene material and your skin. This water then heats up with your body, giving you a layer of insulation that keeps you warm. A wetsuit must fit tight to be effective.
- Dry suit - this is made from waterproof material, which has seals at the neck and wrists so that no water can get in.
- Boots - you can get special neoprene booties, which will keep your feet warm and also give you extra grip.
- Cagoule - Cag's, reduce heat loss due to wind, especially when the canoeist is wet.



## TIP

*Expect the worst and come prepared.  
Wear the correct clothing and you will enjoy your activities more*

# Types of Rowing Craft

You will see many different types of boats in use in Sea Scouting and around the country. Some names used may describe a different type or size of boat, which may have a different meaning in Britain or elsewhere.

## Dinghy

This usually means a small, light sailing boat, with a centre board. However the name “dinghy” may also be used for any small rowing boat or small inflatable boat.

## Punt

This name may also be used for a small rowing boat, and often the words “punt” and “dinghy” may be used for the same craft.



## Skiff

This name is used around the coasts of Ireland for open sea rowing boats, usually clinker-built and pulling 4 oars. They have developed from old pilot or fishing boats and are now used for sea racing. The East Coast Skiff, found between Skerries and Wicklow, is a 24 foot long, double-ended, open sea boat. The name skiff is used for different sizes of rowing boats in West Cork and in Donegal.

## Cot

The word “cot” is commonly used in the South-east, particularly on the rivers Slaney, Barrow, Nore and Suir. The name comes from an Irish word “coite” meaning a small boat. Cots are found in various sizes, but usually – they are flat-bottomed, double-ended, and are usually used for fishing. On the river Barrow the cots are quite small and are propelled by one or two men facing forward using paddles like a canoe.

## Currach or Naomhóg

These are the traditional tarred canvas covered boats found on the West coast. Three distinct types of boat are found in Donegal, Conemara and Kerry. “Naomhóg” is the name given to them in Kerry. They are usually propelled by three pairs of oars, which are mounted on single thole pins and have narrow blades.

## Sea Scout Standard boat





This is the “B.P. 18” which was designed specially for Sea Scouts in Ireland. It is made of fibreglass and is 18 feet long. It may be rowed with 2, 4 or 6 oars and may be rigged for sailing. Many Sea Scout Troops have one of these boats and they are widely used for general Sea Scout training and for regattas and National Competitions.

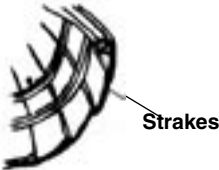

# Boat Construction

Boats may be built from many different materials – wood planking, marine plywood, fibreglass, canvas on timber frame, metals such as steel or aluminium, or even concrete.

In boats made of wooden planking (strakes), the main types are Clinker, Carvel and Diagonal. Boats constructed in any of these ways have a hull which is of a “round bottom” type.

<p><b>CLINKER</b> - the strakes run from bow to stern, overlapping at the edges.</p>	<p>CLINKER</p>  <p>Strakes</p>
<p><b>CARVEL</b> - the strakes run from bow to stern but are fitted together 'edge -to - edge' making a smooth surface.</p>	<p>CARVEL</p> 
<p><b>DIAGONAL</b> - the strakes do not run from bow to stern, but diagonally in two layers, the inner layer at right angles to the outer layer.</p>	<p>DIAGONAL</p> 
<p><b>CHINE</b> - Other types of hull may be “flat bottom” or “hard chine”. The hard chine hull has a narrow “V” shape forward, becoming gradually flatter aft. This is a common shape in small sailing boats and is very suitable for construction from sheets of marine plywood.</p>	<p>CHINE</p> 

# Parts of a Boat

Most of the names for various parts of boats come from the traditional wooden boats, but some of these names may not apply to boats made of metal or fibreglass.

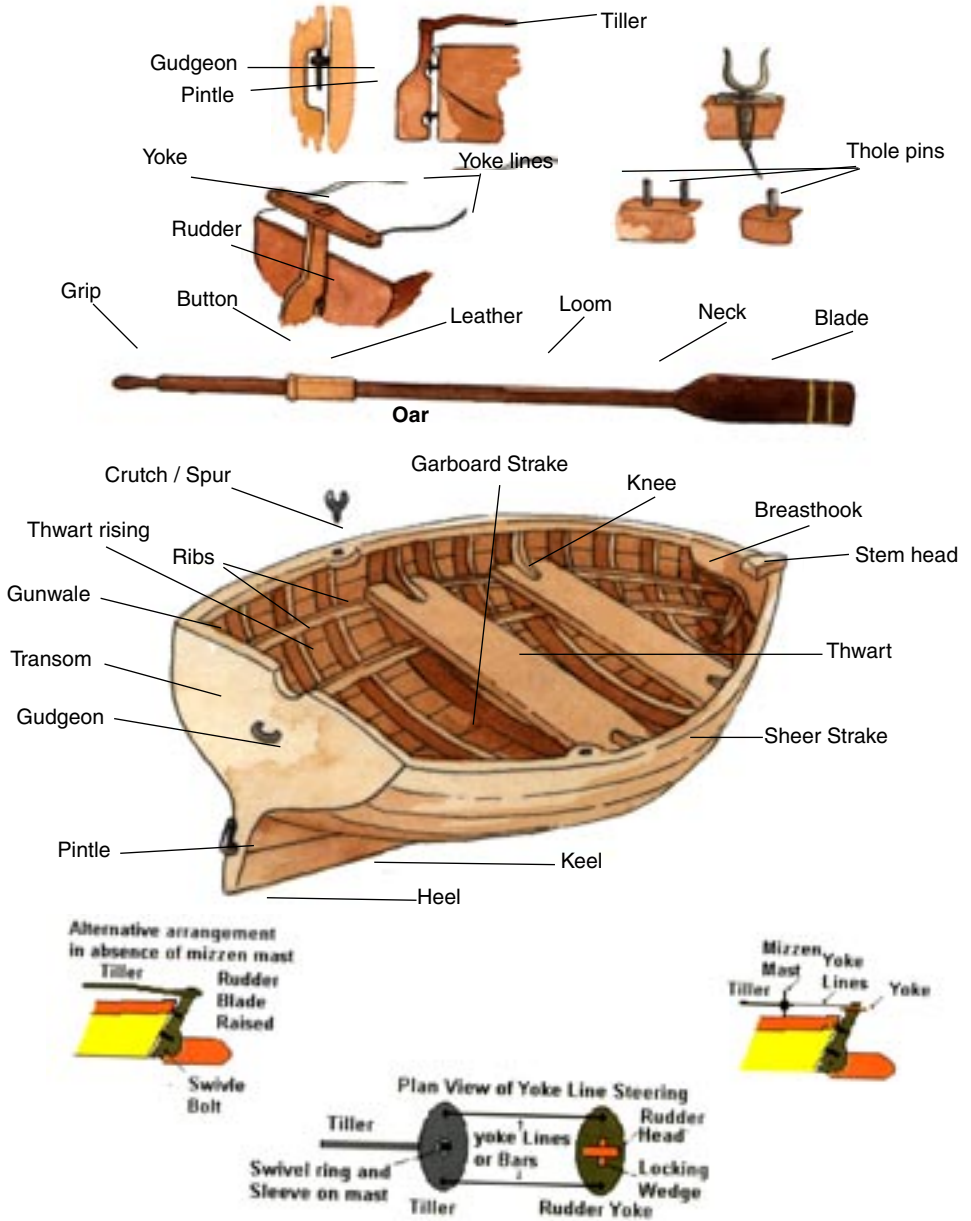



# Getting Into A Small Boat

Small boats or dinghies can be easily turned over if they are not kept well balanced.

## Getting in from a jetty

Get in carefully, stepping from the jetty or steps, hold the gunwale of the boat to keep it steady and step into the centre of the boat - never stand on the gunwale or on the thwarts of a small boat.



## Getting in from the water

Approach from the stern of the boat and then climb in over the transom, as this will keep the boat steady.



## Rescue from the water

A person who has been in the water for a while and is cold, may find it difficult to get into a boat and may require assistance. It is often better to “tumble” them in, head over heels.

If you can't get them into the boat, let them hold on to the transom and row them to safety.

## In the boat

Sit down on the rowing thwart facing the stern. When moving around in a boat, keep your weight low and in the centre.



### TIP

*Never take a person in over the gunwale as a small boat is easy to capsize.*

# Rowing - Dinghy

Rowing in a small boat is the first practical seamanship skill to learn. Small boats are not as stable as big boats and you must learn how to get in and out of a boat properly.

Place the spurs, sometimes called crutches in their sockets and then place the oar looms in the spurs. There is usually a piece of leather or some plastic to protect the oar from wear in the spur.

Hold the oars by the grip, keeping them level above the surface of the water.

## Catch

Then lean your body forward and stretch your arms in front of you and catch the water with the blades of both oars.

## Pull

Lean back and at the same time pull the oar looms towards you - this will pull the oar blades through the water and the boat will move forward.

Pulling on one oar only will turn the boat to the opposite side. Keeping one blade in the water while moving will turn the boat to the same side.

To slow down and stop put **both** blades in the water and keep them there - this is called "holding water".

To make the boat go backwards you must row backward - when you put the blades in the water, push the oar looms away from you instead of pulling them towards you. This is called "back-watering".

Once you have learned to propel and to control the boat you will soon get used to manoeuvring to come alongside, or to pick up a mooring buoy or set an anchor. You should be able to row the dinghy around a course and be able to rescue a man overboard before you are deemed proficient.

When you have reached this degree of proficiency you will be trusted to retrieve the larger boats from their moorings and to act in support of other activities.

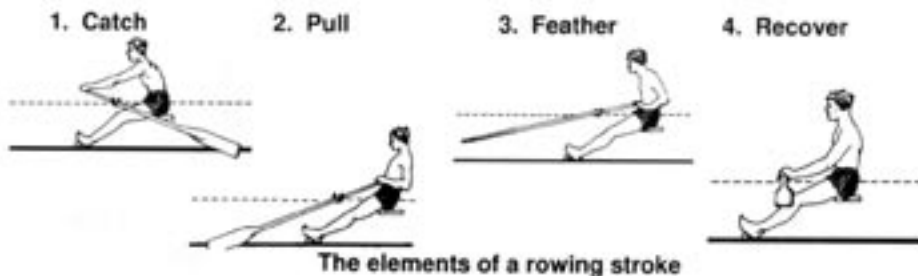

# Rowing - Boat Drill

Your Troop may also have a bigger boat that can be rowed by a crew. This may be a BP 18, a skiff or some other class. These boats will often have 4 oars and each oarsman pulls one oar. There are different ways of arranging oars in multi-oared boats.

An effective pulling boat crew must be able to row satisfactorily in time together, must behave correctly in the boat and follow the directions of the coxswain.

Conduct in a boat is very important. Remember there is only one person in charge and the crew must obey orders immediately. An ill-disciplined, careless crew can be a danger to themselves and to others. A Sea Scout crew should always be well-behaved and a credit to their own Troop.

When rowing, keep your back straight and use the force of your trunk swinging backwards for the main part of the stroke, only bending your elbows when you have leant back as far as you can. Use your arm and shoulder muscles for the last pull on the oar to help you swing forward again.

Do not wave the oar blade too high in the air as you swing forward ("sky-scraping") and do not bury the blade too deeply starting the next stroke.

To direct a rowing crew, a system of rowing orders is needed. There are some different systems in use and it does not matter much which your Troop uses provided you all understand the same system.

The drill given here is the one which has developed over the years as the traditional Sea Scout system.

Crew assembles on jetty or steps. The oars, spurs and rudder have already been placed on board. The oars are laid on the thwarts on the correct sides, blades forward, bow oars inboard of the stroke oars. The rudder is inboard, just abaft the coxswain's thwart. Coxswain embarks first, goes to the stern and ships the rudder.

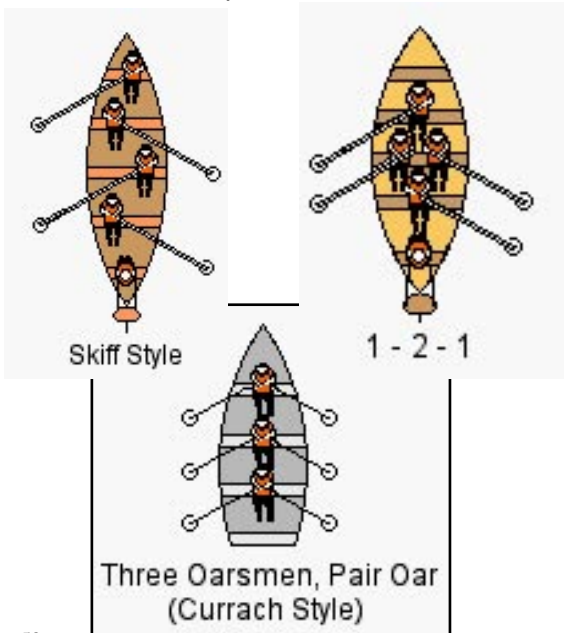

# Rowing - Boat Drill

**“In stroke, In 2nd stroke, In 2nd bow, In bow”** appropriate crew embark .

**“Stand-by bowman”** bowman unhitches the bow-line, but keeps hold of it and does not yet embark. If the boat has a boat hook, bowman may embark and use the boat hook to hold the boat alongside.

**“Ship spurs”**

oarsmen put spurs in sockets.

**“Sight oars”**

oarsmen locate and grip their oars.

**“Toss oars”**

oarsmen lift their oars up vertically, feathered fore-and-aft, in line with each other.

**“In bowman, bear off”** bowman embarks and pushes off from the jetty or wall.

**“Down oars”**

oars lowered on the appropriate sides, the blades touching the water before the shaft touches the gunwale. Oars shipped into the spurs and held horizontally, blades feathered.

If oars are not tossed, the Coxain will use the order “Ship Oars” as the boat is pushed off from the jetty. The oars are lifted out over the gunwale.

**“Fenders in”.**

**“Stand by”**

oars unfettered and oarsmen lean forward.

**“Give way together”**

all start rowing, taking their time from stroke oar

# Rowing - Boat Drill

Other orders, depending on the situation might be –

**“Give way starboard, hold water port”** to turn to port

**“Backwater together”** to go astern

**“Way enough”** - Stop rowing - when that stroke is completed

**“Hold water”** - all oar blades into the water together and hold steady

**“Trail oars”** - swing the oar looms forward so that the blades come into the side of the port - used when coming alongside if you don't want to toss oars onto boat oars or in order to clean an obstacle

**“Easy all / port / starboard”** Ease up

These orders can be combined to steer the boat, e.g.. hold water port, give way starboard would cause the boat to turn to port as in the diagram.

When coming alongside, the Coxswain will order “Way enough” at a reasonable distance from the jetty, taking wind and current into consideration.

“Fenders out” - fenders put out appropriate side. If going too slowly the Coxswain may order another stroke or two, but if going too fast may order “hold water”.

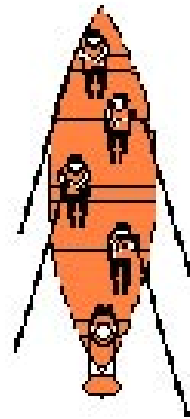

The boat will turn this way

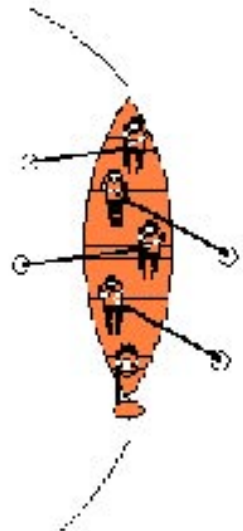

# Types of Sailing Craft



## Sloop

A Sloop is a single masted vessel, fore and aft rigged with one headsail.

## Cutter

Cutter is a single masted vessel with two headsails



## Ketch

A ketch is a two masted vessel fore and aft rigged on both masts and the mizzen mast is tepped forward of the rudder head.



## Yawl

A yawl is a two masted vessel fore and aft rigged on both masts and mizzen mast is stepped aft of the rudder head



## Brigantine

A brigantine is a two masted vessel, square rigged on the fore mast and fore and aft rigged on the after mast.

## Asgard

ireland has a Sail training Vessel 'Asgard II' she is a brigantine. You do not have to know about square rigging, but it would be interesting for you to be able to recognise 'Asgard II'



## Schooner

A two or more masted vessel fore and aft rigged on all masts. In a two masted schooner the after mast is the main mast.

# Sailing

## Rigging a Sailing Boat

You should learn how to rig a sailing boat of a type which is used by your troop. It is hoped that most sea Scout troops will eventually get one of the Sea Scout standard boats (BP 18), and that all Sea Scouts will learn how to rig and sail this craft.

The lower end of the mast (heel) fits into a socket called the **mast step** or larger fitting called a tabernacle. Sometimes the mast may pass through a hole in a thwart which is then known as a sailing thwart.

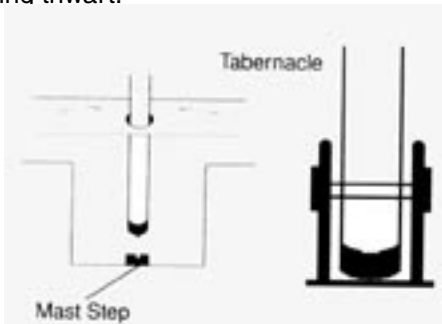

Support is given to the mast by the **standing rigging** which includes all the ropes and wires which are fitted permanently to the mast and which do not normally move. The standing rigging usually consists of a forestay and shrouds. At the lower end is a bottlescrew or lanyard to adjust the tension. On taller masts, the shrouds may be spread outwards on crosstrees or spreaders to give better sideways support to the mast.



Bottlescrew

The shrouds are also brought slightly aft to brace the mast, and in some larger sailing vessels a backstay leads from mast to the stern.

The function of a mast is to support sails. Sails take their names from their position on a craft. In sailing ships of former days, the sails were rectangular and were mounted on yards, which ran across the ship. These vessels were said to be “**square rigged**”.

Most sailing vessels nowadays are “**fore and aft rigged**”, sails being hoisted in a line before and abaft the mast. This arrangement is more efficient for working to windward.



# Sailing

A headsail is any sail set before the fore mast. Headsails are always triangular in shape. In small boats the head sail is usually called the jib. Where there are two headsails, the inner one is usually called the staysail.

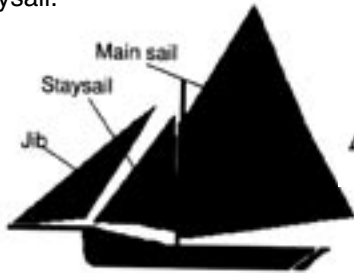

A very large jib which reaches abaft the mast, overlapping the mainsail is known as a Genoa jib.

Another sail which can be set before the mast when there is a following wind is a large and balloon like sail, known as a spinnaker.

The main sail may be either triangular (Bermudan rig) or four sided (gaff rig). Each edge and corner of the sail has its own name.

The main names are given in the diagrams.

Sometimes sails have two or three rows of short lengths of line fixed through the sail. These are called reef points and are used for reducing the area of sail in strong wind (reefing). Lacing eyelets are small metal **eyelets** along the edge of a sail to take the lacing or attachment to the mast and spars.

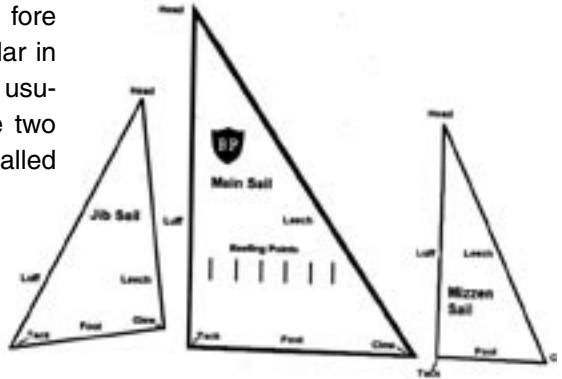

The luff of the main sail may be attached to the mast by means of lacing or metal slides running in a track on the mast, or a "luff rope" running up in a groove in the mast.

**Cringles** are larger metal rings or eyes fixed into the material at the corners of the sail or at both ends of a line of the reefing points.

The clips used to attach the luff of the jib to the forestay are called "**hanks**".

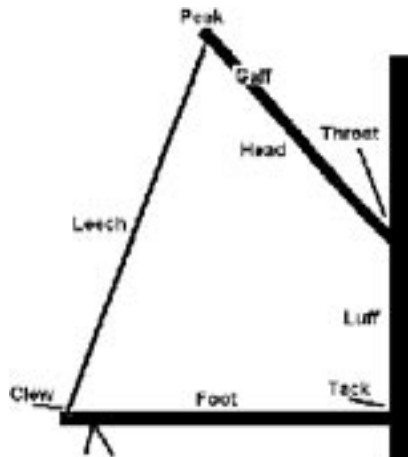

# Sailing

**Running rigging** includes all ropes that move. A halyard is a rope which raises a sail.

Ropes which control the movements of sails are known as **sheets**. They are named after the sails they control. In a larger sailing craft there may be a rope running through a sheeve (pulley wheel) at the masthead and down to the aft end of the boom, known as the "topping lift". The boom is a spar to which the foot of the sail is attached.

If the vessel is Bermuda rigged the main sail will be triangular and therefore there will be only one halyard attached to its head. However, if the vessel has a gaff then the mainsail will be four sided, and the upper edge of the sail will be secured to a wooden spar, the gaff. In this case it will have two halyards, one to hoist the throat of the gaff and the other to hoist the peak - these are known as the throat and peak halyards.

A Mirror dinghy has a gaff

A sprit sail is a four sided sail supported by a spar that runs diagonally across the sail to the peak. This rig is used in the optimist dinghy.

The gunter rig is similar to the Bermuda in that the mainsail is triangular, but the upper part of the luff of the sail is laced to a gaff which is hoisted perpendicularly,

in line with the mast, and not at an angle to it. This type of rigging is seen on a number of modern dinghies such as the Mirror dinghy. The mast and the spars are all short and can fit inside the boat as it is being trailed or stored.

## Shortening sail

As wind increases in strength and a boat is "overpressed", sail area should be reduced and handling then becomes much easier. The commonest way to shorten sail in a dinghy or BP 18 is by "reefing" the mainsail. In larger craft the jib may also be reefed or replaced by a smaller sail.

**Reefing** a sail means making it smaller, and this may be done by tying down "reef points", by "slab" reefing or by "roller" reefing. In a BP 18 the mainsail may be lowered completely in a strong wind and the boat sailed with jib and mizzen - it will not sail very well closehauled with this rig, but will be quite comfortable on a reach.

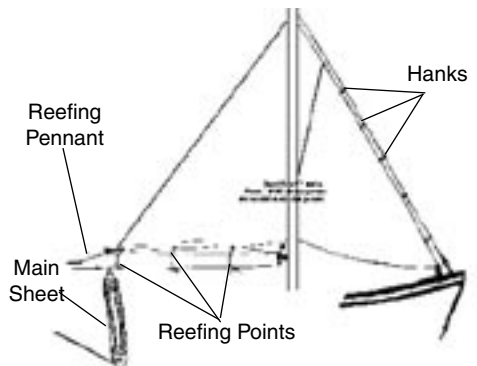

# Sailing

A sailing boat cannot sail directly into the wind, but can probably “point” about 45° off the wind. Progress to windward is made in a zig-zag manner by “**tacking**”.

When sailing close to the wind like this, the sails are sheeted in tightly so that they are as flat as possible. This is called sailing “**close-hauled**” or “**beating**”. If you turn too close to the wind, the sails will shake and will not draw properly. This is called “**luffing**”. Coming head to wind the boat will stop and is said to be “**in irons**”.

If the wind is on the beam, the sheets are eased - the sails can fill better and develop a curved shape. This is called “**reaching**” and is usually the fastest point of sailing.

When the wind is astern the boat is “**running**”. If the jib is blanketed by the mainsail and does not fill, it can be set on the opposite side to the mainsail, perhaps boomed out with a spinnaker pole or a smaller spar called a “jib stick”. This is known as “**goose-winging**” or “**running goose-winged**”.

When beating or reaching there is a tendency to slip sideways due to the sideways push of the wind. This is called “**leeway**”. The amount of leeway depends on the design of the hull and the keel, or in small craft by the centre-board.

Try to sail a BP 18 or a dinghy close-hauled with the centre-board raised and you will find that most of the movement is sideways and you will make very little progress to windward.

A **Gybe** is when the boom moves across from one side of the boat to the other when the wind is astern.

**Sail setting** - make sure that the sails are properly and fully hoisted. Check downhauls and outhauls, and kicking strap. A well set sail should have no creases running across it.

Adjust the sheets to the point of sailing - they should be pulled in tight when sailing closehauled, but otherwise should only be as tight as required to stop the sails flapping.

# Sailing

**Boat trim and balance** - Sailing with most of the crew weight too far aft causes the bow to be too high out of the water, changes the underwater profile of the hull and means that the boat will not sail so well - it will be slower and will probably have more leeway.

If there is too much weight forward, the stern will be too high and the rudder will therefore lose some of its effect, making steering difficult and also increasing leeway. So keep the boat properly trimmed - the weight a little forward when closehauled. This is very important in a BP 18 as the bow is naturally high. It is quite correct to bring weight further **aft** when **running**. The position of the crew is also very important in maintaining the side to side balance of the boat.

Depending on the strength of the wind the crew may have to sit up to windward or even sit out on the gunwale. Therefore on different points of sailing, maintaining trim and balance by moving the crew around is almost as important as continually adjusting the sheets.

Good sail balance means that the boat will naturally tend to come bow to the wind when the tiller is let go. This is called "**weather helm**" and is a safety factor, as the boat will become upright and stop. If the boat tends to swing away from the wind, causing more pressure on the sails this is called **lee helm** which can be dangerous as the boat will tend to sail away if you fall over board.

## POINTS OF SAILING

In Irone



Close Hauling



Heaving



Running



Broad Hauling



# Sailing

**Triangular course** - this is a standard sailing test as it means that all the points of sailing are demonstrated.

You are expected to sail the course "to best advantage" - this means to sail around in the most efficient way, not necessarily to race.

However Scouts who have experience of racing will obviously have no difficulty here.

Remember that you can raise your centreboard fully when running, and partly when on a broad reach.

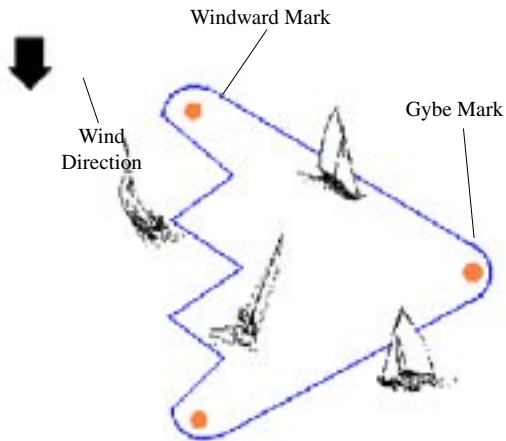

## Man Overboard

If a crew member should fall over board its important to recover them quickly. The gybe method is quicker but the figure 8 method may be better in rough conditions.

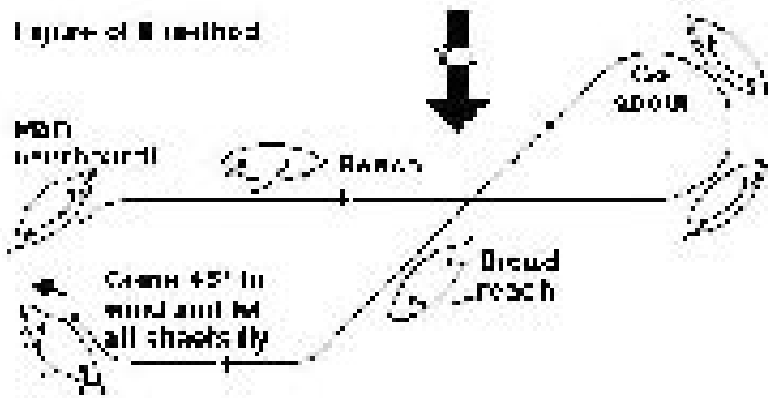

# Capsize Drill

Open sailing boats and dinghies often capsize and learning to right the boat is part of learning to sail. All Sea Scouts who sail should take part in capsize drills regularly so that they are proficient when the unexpected capsize occurs.



Capsize drill is related mainly to sailing craft, but other craft may occasionally capsize.

1. Stay with the boat - it is much easier for rescuers to see a boat in the water rather than a swimmer's head.
2. Are all crew present? Is anyone still under the boat?
3. If possible, right the boat. However if a craft has no buoyancy, it may be better to leave it capsized as there will be air trapped underneath and it will float well.
4. Crew members should be roped together or to the boat to prevent anyone drifting away.
5. One person may sit or stand up on a capsized boat to signal for help.



# Capsize Drill

The helmsman must position his crew and arrange for leverage downward on the centreplate and on the upper side of the boat to help right it.

The leverage should quickly start the righting process but if the wind is very strong, the mainsail should be lowered by releasing the halyard, and pulling the sail into the boat before trying to bring the capsized craft upright. As the boat starts to come up, the crew member floats into the boat from the opposite side. He is thus scooped up as the boat becomes upright. The crew may help the helmsman on board, over the stern.

The boat should then be bailed out. If the boat has more than two in the crew, the remaining crew members should stay in the water, holding onto the boat at the bow until enough water has been bailed out to make her stable.

If the top of the centre board casing is below the level of the water, it may be very difficult to empty the boat, and so the centreboard case may have to be plugged by using a sail bag or even the sail.

If a boat cannot be righted, it may be possible to climb onto the upturned hull.





# Power Boating

Like any outdoor activity, power boating is not something that can be learned from a book and requires actual practice. Some useful points are given here, the manoeuvres are also only a guide as boat, wind, tide and weather may change the way you do things; experience and practice is the best teacher.

Power Boating in Scouting falls into two main groupings:-

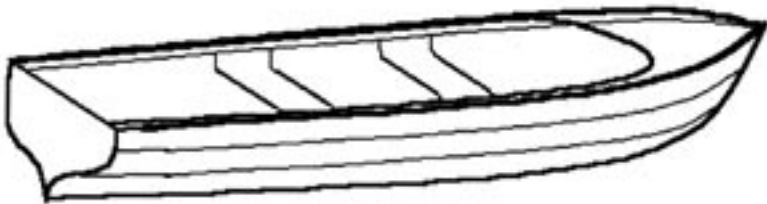

1. Support Craft - slower boats are used to assist in getting from A to B, maybe carrying the heavier gear on an expedition. They usually have a displacement hull. They sit in the water even when underway.

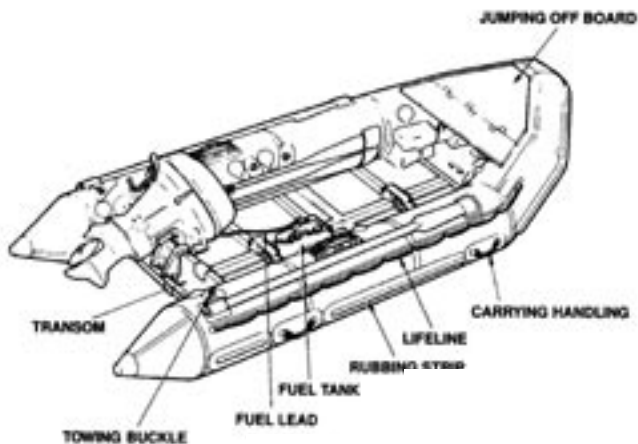

2. Rescue - boats that are used for safety and rescue in water activities. These are faster craft and require the ability of the helmsman to manoeuvre without impeding or annoying those being covered or any other craft in the vicinity. They have a planning hull. They skim on the water when underway.

# Power Boating

Outboard engines require oil and petrol, either mixed together or put in separately. You should check with your Watch Leader or Leader what is the correct mixture for the engine(s) your Troop uses and how this is done.

The equipment required for a small boat going out for a half day's activity in normal boating waters is:-

- 2 oars, spurs or paddles
- Bailers
- Anchor and rope
- Bow and stern lines (painters)
- Tow-line
- Ignition key\*
- Kill-cord\*
- Battery\*
- Small fire extinguisher
- Fenders
- Lifejackets or Buoyancy aids
- Emergency fuel tank (small)

The additional equipment required in a small boat for a day's activity:-

- Horn or whistle
- White light (torch)
- Compass and chart
- Lifebuoy or heaving line
- Distress flares
- Fire blanket
- First aid kit
- Tool kit and engine spares
- Means of summoning help

A VHF radio or other means of summoning help is needed and in particular when you leave your normal boating water. Mobile phones might not get a signal.

All the equipment should be cleaned and put away after use. Particular care must be paid to storing fuel to minimise the fire hazard. Store it in a well ventilated space, well away from sources of ignition.



# Power Boating

## Handling an outboard engine

Be careful about lifting and handling outboard engines and do not attempt to carry a heavy engine on your own . . . get help. Your Watch Leader or Leader will show you how to best lift and carry an outboard engine. Do not step into the boat carrying the engine, pass it across to someone else who is already in the boat; or put it down, step into the boat and then lift it in.

Bigger engines are often left attached to the boat, tilted up out of the water and the fuel tank is disconnected and taken ashore when not in use.

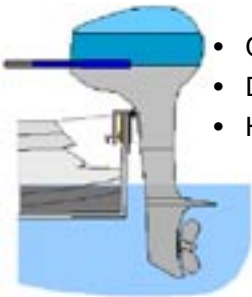

- Centred
- Down fully
- Hand tighten clamps

**Note:** Check clamps after 15 minutes operation. The engine should be securely tied or chained to the transom.



### — TIP —

*If fitting in shallow water, put the engine into the tilted position on the bracket before lifting onto the transom. This will avoid dragging or digging the propeller in sand or silt.*



## How to start an outboard engine

1. Check the engine is secure.
2. Check the “gear lever” is in neutral position.
3. Ucoil the fuel line completely.
4. Open the “vent screw” on the fuel tank
5. Squeeze the fuel line “primer bulb” several times until resistance is felt.
6. Fit the “kill switch” cord. (If applicable).
7. Move the “throttle” to the start position.
8. Cold engine: Pull the “choke” out all the way.  
Warm engine: Do not choke. If the engine fails to start after a couple of tries, then use the choke.
9. Pull “starter cord” slowly until starter engages, then pull forcibly. Ensure the starter cord fully rewinds before letting go.

# Power Boating

11. Gradually push the “Choke” in, until the engine is running smoothly.
12. Check for a flow of water coming out of the “Cooling water” exit. If there is no water coming out, stop the engine immediately.

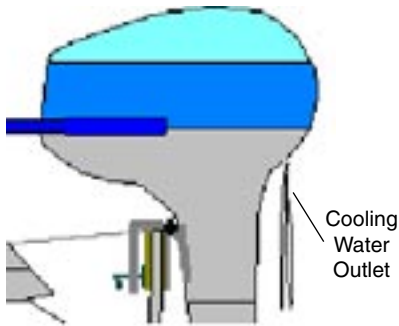

13. Put the “Kill Switch” around your wrist or other suitable location (if fitted).

## How to Stop an Outboard Engine

1. Reduce the “Throttle” all the way to the gear change position.
2. Move the “Gear Lever” to the Neutral position.
3. Pull off the killcord or push the stop button.



### TIP

*Don't run the engine at full speed until it has warmed up.*

## How to move forward at varying speeds on a straight course.

1. Ensure the “Throttle” is at the gear change position.
2. Look where you want to go and that the way is clear to proceed.
3. Move the “Gear Lever” into the Forward position.
4. Pick a fixed mark that is in the path of where you want to go (moored boat, tree, quay wall, etc.) and point your bow at this, when you see the bow off this mark, compensate by steering slightly until your bow is again pointing at this mark. Try to steer with small changes.

When going across a current or a tideway, you must steer to make allowance for the tide.

The throttle is used to increase or decrease speed. Always use it carefully, do not open the throttle too quickly and watch where you are going.

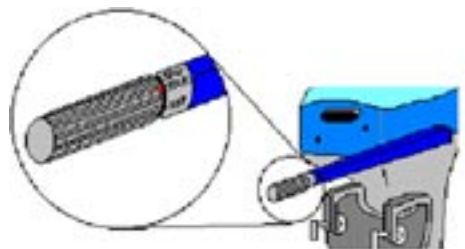

# Power Boating

## How to turn

1. Using a tiller:
  - Move the tiller over to port; the boat will go to the starboard.
  - Move the tiller over to starboard; the boat will go to the port.
2. Using a steering wheel
  - Like in a car, the way you turn is the way you go.

If you turn “hard” in either direction, the boat will do a tight turn. At fast speed this sudden movement could throw someone out of the boat.

A boat with a planing hull will be more manoeuvrable than a displacement hull.

## How to reverse

1. Ensure the “throttle” is at the gear change position.
2. Turn around, look astern and check that the way is clear to proceed.
3. Check the automatic tilt is locked in place (if fitted).
4. Move the shift lever firmly into the reverse position.
5. Pick a fixed mark. Remember you turn toward where you want to go.



### TIP

*If you reverse too fast you run the danger of shipping a lot of water in over the Transom, particularly in small boats.*

## How to come alongside or picking up a mooring buoy.

1. Approach into the wind or current (whichever is stronger) if possible.
2. Reduce speed when approaching,
3. As you get closer, reduce speed enough to just make headway.
4. When one boat length away, turn your bow away from the boat or buoy and put the engine into neutral. (If wind / tide is strong you may have to keep the engine in gear).
5. Ensure to put the gear lever into neutral.

If you need, put the engine into reverse to bring your stern closer to the other boat. Be careful carrying out this operation because if you misjudge and run over the line, you run the risk of fouling your propeller.

# Power Boating

## Emergency stop

Normally to stop your boat, you close the throttle, put the gear lever in neutral and drift slowly and stop. If it is necessary to stop more quickly:-

1. Turn hard to the port or starboard.
2. Move your throttle to the slow speed.
3. Move the gear lever into neutral.

Making a sudden turn like this slows the forward momentum of the boat.

This will work well in an inflatable, but a boat with a long, straight keel will not turn quickly and it may require engaging reverse gear.

## The Do's and Dont's of an outboard when finished boating

### Do

- Let the engine stop itself by unplugging the fuel line.
- Remove the kill switch (if fitted).
- Close the vent screw on the fuel tank
- Run the engine in fresh water, to flush out salt and sand.
- Clean the engine down with fresh water and dry off.
- Coil up the fuel line. Keep the connection clean of dirt or water.
- Store the engine in an upright and safe position.

**Don't** carry the propeller higher than the engine.

**Don't** store the fuel tank near sources of ignition.

**Don't** submerge the engine in water. If this happens inform the leader in charge quickly.

# Power Boating

## Man Overboard

You need to ensure that you do not run over or hit the casualty in the water with your propeller.

1. Approach into the wind or current (which ever is stronger) if possible.
2. Reduce speed when approaching, (distance depends on wind & current)
3. Point your bow to approach the casualty on your side (important to be able to see the person)
4. Reduce speed just enough to make headway.
5. Indicate clearly for the casualty to stay still, you will come to them.
6. When one boat length away, slow down and put the gear lever into Neutral.
7. Let the casualty swim to you. If they cannot, reach out with an oar / paddle or throw a heaving line.
8. Bring them alongside the boat and help them climb in keeping the boat trim.
9. If they can't get in, get a crew-member to help hold the casualty to the side of the boat and tow them to safety.

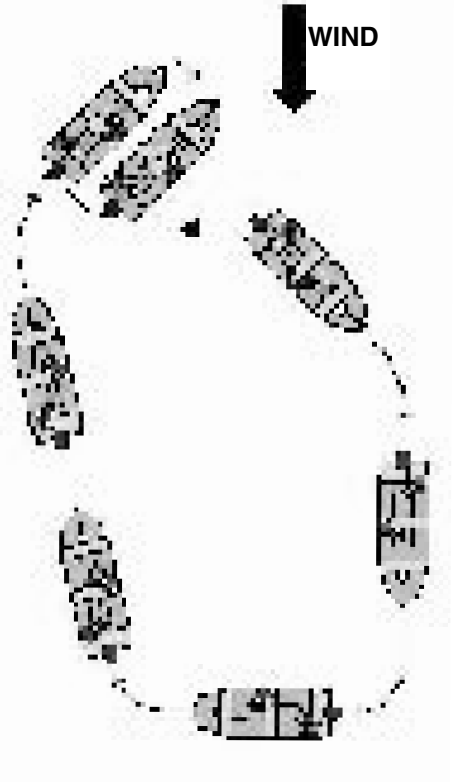



# Types of Craft

## The Ship Silhouettes

The characteristics of the ships to be seen in Irish waters and their purpose.

### Container Ship



Container ships are large modern ships and easily recognisable with the containers stored on deck.

### Trawler



Trawlers come in many shapes and sizes. The traditional inshore trawler usually has a wheelhouse aft and a large derruk forward for hauling nets. It may also have a mizzen sail to help with manoeuvrability.

### Bulk Carrier



Bulk carriers are large vessels for carrying cargos such as coal grain and ore. They look similar to a VLCC except the hatch coamings can be seen and they rarely carry their own cranes or derricks.

### Car Carrier



Car carriers are large floating car parks for transporting cars around the world. they are a large box like construction with ramps in their side and at the stern.

### Lighthouse Tender



The modern lighthouse tender has a superstructure forward with a large low working deck aft. It also has a large crane for handling buoys and cargo.

### Passenger boat / car ferry



Easily recognisable by their high superstructure windows and lifeboats along each side.

### High Speed Ship HSS



These large vessels are usually of catamaran construction with water jet engines. They have a sleek aerodynamic design and two ramps at the stern.

# Canoeing

A kayak is a closed deck boat propelled with a two bladed paddle. In Ireland, a Kayak is often called a canoe.



A canoe is an open boat propelled with a single bladed paddle. In Ireland a canoe is frequently called a Canadian canoe or just a “Canadian”.



Canoeing is an exciting activity because of the adventure and uncertainty it brings. It may be the first time you will be in charge of your own boat and you have to rely on practising the skills yourself rather than depending on others.



## TIP

*Remember . . .  
less than three  
should never be.*

## The main safety points of canoeing

- Don't canoe if you cannot swim
- Always wear a buoyancy aid
- Ask about local dangers, tides, currents, etc
- Don't canoe with less than three people and always tell someone ashore your plan.
- Don't overload a canoe with people or equipment
- Helmets must be worn at all times
- Spray decks must be worn
- A qualified person must be in charge.

## Safety when lifting heavy loads (canoe)

Care should be taken when carrying a canoe to and from the water, if it too heavy get someone to help you carry it. When the canoe capsizes it may be very heavy due to the weight of the



# Canoeing

## Parts of a Kayak

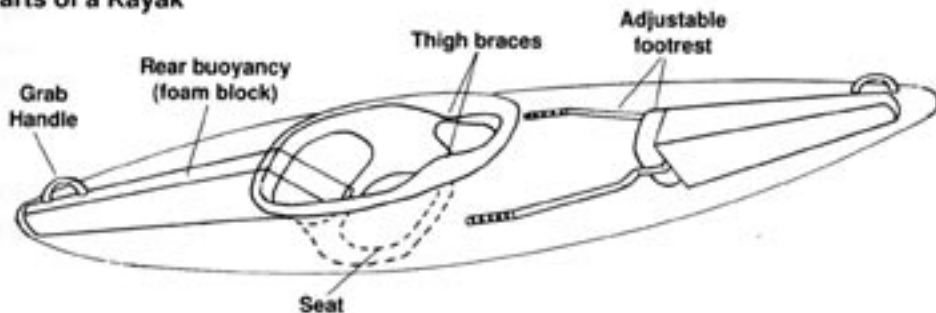

## The equipment required

The equipment required for a canoe going out for a half day's activity in normal boating waters:-

- Paddle
- Helmet
- Spraydeck (not for Cubs)
- Buoyancy aid

## The additional equipment required for a day's water activity.

- Horn or whistle
- White light (torch)
- Compass and chart
- Throwing line
- Distress flares
- First aid kit
- Spare paddle
- VHF radio or other means of summoning help (note:- mobile phones may not get a signal)



## How to hold the paddle

Most paddles are what is known as right hand control. That is, the paddle is held firmly by the right hand and loosely enough in the left so its free to turn.

# Canoeing

## Entering a kayak

Place the canoe in the water, leaving the paddle beside and in reach of the canoe. Holding onto the front of the cockpit with one hand, kneel with one leg, step the other foot into the canoe.

Maintaining a hold with each hand (one on cockpit and the other on the jetty), bring the other foot into the canoe. Bring both legs down and get your balance, reach and take hold of the paddle, ready for paddling.

## Exiting a kayak

Getting out is the same as getting in except done in reverse order.

## Sitting properly

Once in the Kayak sit in an upright position, with your feet resting comfortably on the footrest.

You may rest your knees then along the sides of the kayak, this will also help you keep your balance and not move around in the kayak.

## Paddling forward

Reach as far forward as you comfortably can with the paddle. Grip the water and take a stroke . . . in at your knees and out at your hips.

Take the next stroke on the other side. Keep the paddle as close to the kayak as possible and try to make this a smooth, continuous flow of movement, with a rotation of your body as you move rhythmically along.

As you pull the right blade back, your right foot should press on the footrest, similarly left blade, left foot.

By combining sweep strokes with normal strokes you can keep on the straight and narrow.

## Sweep stroke (turning)

The sweep stroke starts off like a normal stroke but you sweep the paddle out wide and continue all the way to the stern. You can also do a reverse

# Canoeing

Padding Forward



Notice paddle is close to the boat

Sweep Stroke



Notice paddle is swept wide



## Padding in reverse

You must reach backwards to put the paddle into the water, looking over your shoulder as you do so. Notice that you use the back of the blade as you push yourself backwards and be careful that it strikes the water flat as it goes.

Again the blade is taken from the water as your elbow passes your hip and there is plenty of twist at your waist.

## Stern rudder

A useful stroke to turn a kayak is the stern rudder.

While the canoe is in motion, lift the blade to the rear and trail it in the water. The bow will then turn towards that side. The diagram shows a stern rudder on the right. You can do a stern rudder on either side. A stern rudder only works if the boat is moving.



# Canoeing

## Capsize

- Capsized
- Take spray deck off
- Push out of the canoe
- Surface and hold canoe
- Swim canoe and paddle to shore
- Empty canoe

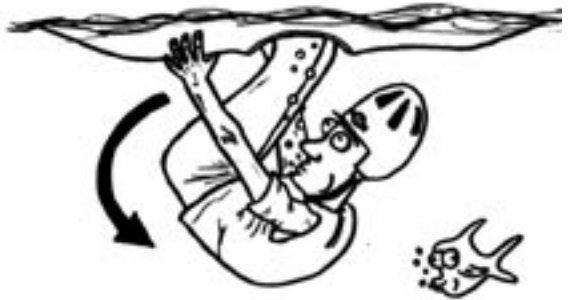

## H Rescue

A rescue canoe is positioned across each end of the capsized canoe, this then forms the letter "H". The capsized canoe is rolled onto its side and raised simultaneously from both ends.



This operation will get most of the water out and when the canoe is light enough it should be turned completely upside down and the remainder of the water should be drained out, by raising and lowering each end in turn. The advantage of doing this in a canoe is that one person in each canoe can maintain position and the other person can perform the rescue.

# Canoeing

## Slap support

These strokes are designed to bring you upright should you unexpectedly begin to capsize. To practice, have the paddle horizontal with one blade flat. Fall towards the flat blade and as you pull down sharply on the blade, lever the canoe upright with your hips. When you are upright, twist the blade through 90 degrees and so take it out of the water again. You should be able to do this on both sides.



## Raft Up

Forming a group of canoes together into a raft up makes a stable base for rescue, repair, lunch or just fun. A canoeist is chosen as an anchor person and everyone else forms up to this person, all facing in the same direction. Each canoeist should hold onto each canoe that is beside them, the best place to get a grip is the cockpit. The paddles are then laid down across the front of the canoes.

## Draw Stroke

This stroke is designed to move the canoe in a side-ways motion. Put the whole paddle as vertically as you can, out a little way from the side of the canoe and with the face (hollow side) of the blade flat towards you. Pull the paddle towards your body and the canoe will move sideways towards the blade.

Just before the blade reaches the side of the canoe twist it quickly through 90 degrees by rolling your wrists out and push it gently back out to where you started. Then twist it again through 90 degrees so that it is now in the position at which you started.

(See diagrams)





# Rafting

A raft is probably the simplest way to get afloat, is certainly the cheapest and can be great fun.

Essentially a raft is made of two components. Something to keep it afloat (buoyancy) and something to keep it all together. We'll call it the frame for want of a better word.



**Frame on tubes**

## **Buoyancy**

Anything that floats will work. Inflated tractor or car tubes, (your local tyre center or garage may usually give you these free of charge). Steel oil drums with lids, plastic barrels or something like polystyrene blocks.

It is even possible to make buoyancy from inflated and tied black plastic sacks if you are careful.



## **Coracle**

A large lorry or tractor tube and some builders plastic sheeting craftily assembled can make a traditional coracle for one person. As you can probably get the tube for free and builders plastic sheeting is quite cheap, you can get afloat for next to nothing. Remember to put some supports in the bottom, like old carpet to spread the weight on the floor.



**Coracle**

# Rafting

## Buoyancy

A securely lashed square frame can have four large inner tubes lashed to it and a raft for two or four people can be quickly assembled.

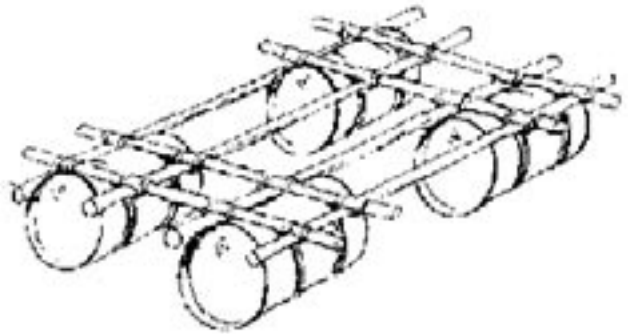

If you are using barrels ensure they are free of any chemical or oily residues, which would cause pollution or harm you or the environment.

Each litre of buoyancy will support 1kg. Don't forget the weight of the spars and the barrels or tubes, remember the more buoyancy, the higher (and drier) you will float.



### TIP

*Be Careful, rafts are not as manouverable as boats.*

*SAFETY - Safe Waters - Sheltered - Buoyancy Aid*

Decide how many people are to be kept afloat. Sometimes it's better to build two smaller rafts rather than one huge one. Remember you are going to have to carry it on and off the water.



# Boat Maintenance

Since boats are quite expensive pieces of equipment, it is obviously very important to maintain them correctly and to repair any damage as it happens. **A Scout is THRIFTY.** It should be considered a part of normal activities for all Sea Scouts to take an active part in this maintenance in keeping with their experience and skill and in some Troops each Scout is expected to “clock-in” a certain number of hours boat work before they are allowed go afloat. **A Scout is HELPFUL.**

As you gain experience so you will be expected to take a more active role in this work, including supervising members of your watch and doing some simple repairs. **A Scout is TRUSTWORTHY.**

You'll get credits towards the various badges for the work which you do in your ordinary winter maintenance programme.

Most of the regular maintenance will take place during the winter months. At the end of the boating season, the boat should be taken out of the water and immediately washed down with fresh water, and weed growth scraped off the bottom, mud and dirt washed off all moveable parts (bottom boards, rudder, oars and spurs) removed and stored indoors. If possible the boat should be stored under cover, or at least upside-down. If a tarpaulin cover is put over a boat, it is a good idea to

raised with some sort of “ridge pole” and to leave openings, either at the bow and stern or under the edges of the tarpaulin for air to circulate around the inside.

At this stage sails should be washed in fresh water and dried thoroughly before storage and standing rigging should be inspected for wear and replaced if necessary.

Paint on a boat is not just to make it look pretty. It also helps to protect the structure. Any wooden boats will probably need to be sanded and painted or varnished. If the paint is in particularly poor condition it will need to be stripped off completely, possibly with a heat gun or with chemical paint strippers. These are potentially dangerous and should be used with care by people who have been shown how to use them properly. **A Scout is not a FOOL.**

Minor repairs to timber or glass fibre gunwales, decking, etc. may be required also.

It may even be necessary to fit a tingle to a wooden boat.

**HOW?**

Sanding generates a lot of dust and appropriate face masks should be worn. If the existing paint is still adhering to the wood then only a light sanding will be required.

# Boat Maintenance

Use a medium grade of sandpaper and sand only lightly. The idea is to “cut” the existing paint, that is to barely take the shine off it, so that the next coat of paint will stick to it. Any loose paint will need to be stripped off, probably with a paint scraper. You should be careful not to damage the boat. The edges of an area like this need to be sanded smooth.

When the surface has been sanded it is ready to paint. Before painting read the instructions on the tin, does it need to be shaken, stirred or diluted?

During painting try to be careful not to get too much of the paint on yourself, your friends or on the paintbrush. You will do a better job with only a little paint on the brush and go back to the pot often.

If any bare wood is exposed it is best treated with a primer first. After that has dried, use an undercoat and then one or two coats of gloss paint. If two coats of gloss are used you will need to give a very light sanding between coats.

With varnish a coat of varnish diluted with white spirits should be used as a primer on bare wood.

Two or three coats of full strength varnish will be required on a varnished boat with a light sanding between coats.

The brushes should be cleaned thoroughly after use otherwise they get hard and useless.

Any boat kept on a mooring throughout the summer may need to have anti-foul paint below the water-line to stop weed growing. This paint contains a poison and you should be careful not to get any splashes on your self. It is best to wear protective gloves. Always wash your hands thoroughly after any painting job.

## **Glass-fibre repairs**

Many Scout boats and canoes are now made of fibreglass and generally speaking the routine maintenance of these boats is easier than wooden boats. It will be important to learn how to do small glass-fibre repairs. One of the secrets of good glass-fibre repairs is good preparation. Any loosened or splintered pieces must be removed and the surrounding surface must be roughened with coarse sandpaper or a file. Repairs are made using a cloth made of glass fibres called chopped strand mat (CSM) and resin. The pieces of CSM are cut out in advance and the resin is prepared by mixing in the correct amount of hardener. This job must be done quite quickly once started because resin will not stick well to anything once it has started to set. When you have seen a couple of repairs being done you will be able to undertake one yourself under supervision. Whenever using any chemicals (including paints, anti-fouling etc.) any person working with it should read the instructions first and be sure they understand them.

# Anchoring

An anchor is used as a temporary mooring or to hold a boat in position in an emergency.

The nature of the sea bottom is important in anchoring as to how well it will hold your anchor. Mud gives the best hold. If you anchor regularly in the same ground you will probably have an anchor that is suitable.

The standard anchor is the Fisherman's Anchor or Admiralty Pattern, which is useful in most circumstances for small boats.

The CQR and the Danforth anchors give a better weight for weight.

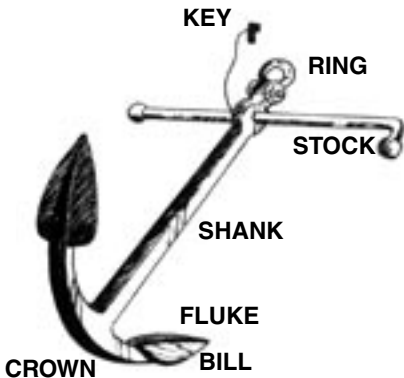

**ADMIRALTY PATTERN or FISHERMANS ANCHOR**

## How an Anchor works

An anchor lies on the ground and its fluke bites into the mud or sand when the pull is horizontal. Therefore a short length of chain between the anchor and the cable (rope), will help to weigh the cable down.

## Choice of Anchorage

When anchoring remember, the boat may swing around depending on the tide or wind, for the time the boat will be at anchor.

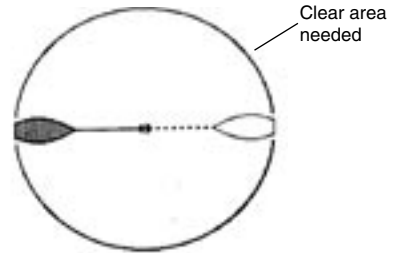

## Swinging circle with single anchor

You must be sure that if your boat turn on the tide or wind that it will not run aground or be likely to bump into other vessels during slack tide.



**Lying to a single anchor**

You can reduce the turning circle of your vessel by deploying a kedge anchor diametrically opposite to your main anchor.

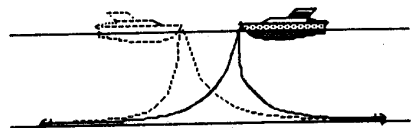

**Lying to two anchors (kedging)**

# Anchoring

## Length of cable

When anchoring a vessel it is important to lay out the correct amount of cable (anchor rope), five times of the depth of water present or expected. For three metres of water you need fifteen metres of cable. More may be needed for foul weather.

## How to anchor

1. Tie the rope to the anchor and boat.
2. Before letting the anchor go, make sure the vessel is moving astern.
3. Pay the rope out slowly as the vessel drifts backwards to avoid “tripping” the anchor.

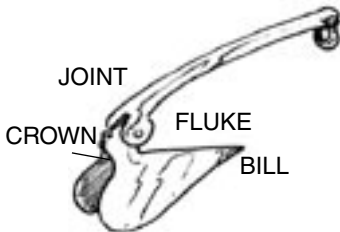

**CQR ANCHOR**

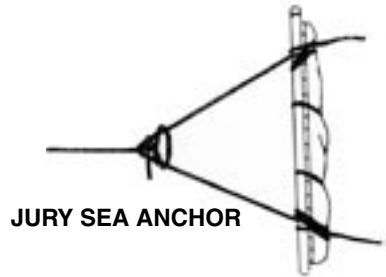

**JURY SEA ANCHOR**

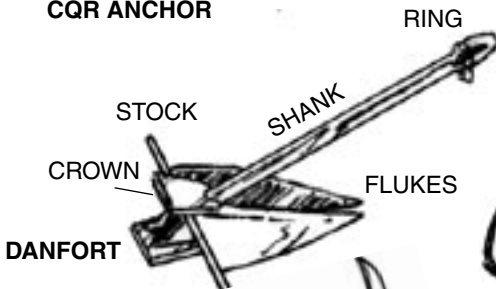

**DANFORT**

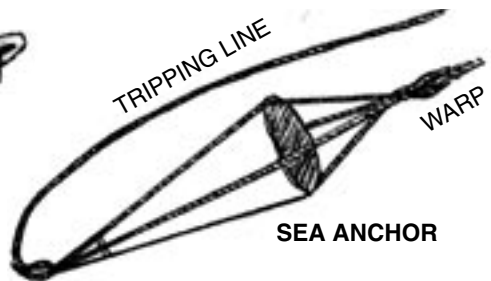

**SEA ANCHOR**

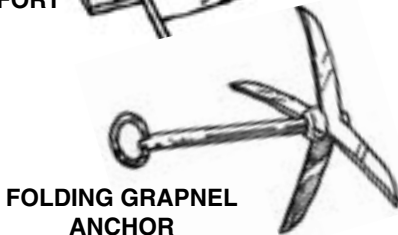

**FOLDING GRAPNEL ANCHOR**



## TIP

*Always check your anchor and cable before you set sail.*

# Tides and Currents

## Tides

The gravitational pull of the moon and to a lesser extent, the sun, on the seas and oceans of the earth, causes tides. This pull causes the water of the sea at any particular place to get deeper or shallower in a definite rhythm. The rising tide is called the “flood” tide and the falling tide is called the “ebb” tide.

The time taken by the tide to flood and to ebb varies in different places but around the Irish Coast the average is about 6.25 hours each way. This means about 12.5 hours between two high waters (HW) and 12.5 hours between two low waters (LW).

## Spring and Neap TIDES

At the times of **full moon** and **new moon** the high tides are higher and the low tides are lower than average. These are called “**Spring tides**”. When the moon is at **first** or **third quarter** the high tides are not so high and the low tides are not so low. These are called “**Neap tides**”. Spring tides occur every fortnight. Neap tides also occur at fortnightly intervals between Spring tides.

## Tide times

Times of HW and LW are found in “tide tables”. You should know how to read tide tables and find the times of high and low water for your normal boating area.

## Tidal currents

As well as the rise and fall of the level of the sea due to the tides, there are also horizontal movements called “Tidal streams”. In some places these streams or currents can be quite strong. Strong currents can cause overfalls in some places. You should learn about Tidal currents in your own area and know which way they run at different stages of the tide. The **flood stream**, when the tide is rising, is usually in the opposite direction to the **ebb stream**, when the tide is falling.

## Effect of wind

Wind blowing over the water causes waves; the stronger the wind, the bigger the waves. Wind blowing against the tide can cause bigger and breaking waves, sometimes dangerous for small boats. Find out about local currents in your Troop’s boating area, and what problems may be caused by a change of direction of tide or wind.



# Tides and Currents

## Depths

The charted depth of water is usually the least depth, that can be predicted by calculating the gravitational pull of the moon, and to a lesser extent the Sun. The lowest tide that can be calculated is called the “**Lowest Astronomical Tide**” (**LAT**). This level may be altered by unpredictable events such as wind strength and direction. Most of the time the actual depth of the water will be greater than that marked on the chart, and will only fall to the charted depth a couple of times in the year.

The difference between the **charted depth** and the **actual depth** is the “**Height of the Tide**” at that time. For example, if the chart shows a depth of 4 metres at a certain place and the Tide

Table shows the height of High Water is 3 metres, then the depth of water at that place at the time of high water will be  $4 + 3 = 7$  metres.

Areas of sand, mud or rocks which are covered by high tide, but exposed at low tide are coloured green in metric charts, and the height above the Lowest Astronomical Tide is indicated by a figure with a line underneath. This is known as the “**Drying Height**”. All heights or depths are related to the Lowest Astronomical Tide except the heights of lighthouses and clearances under bridges which are related to the height of High Water Springs.

The “**Range of the Tide**” is the difference between the height of High Water and the height of the preceding or following Low Water.

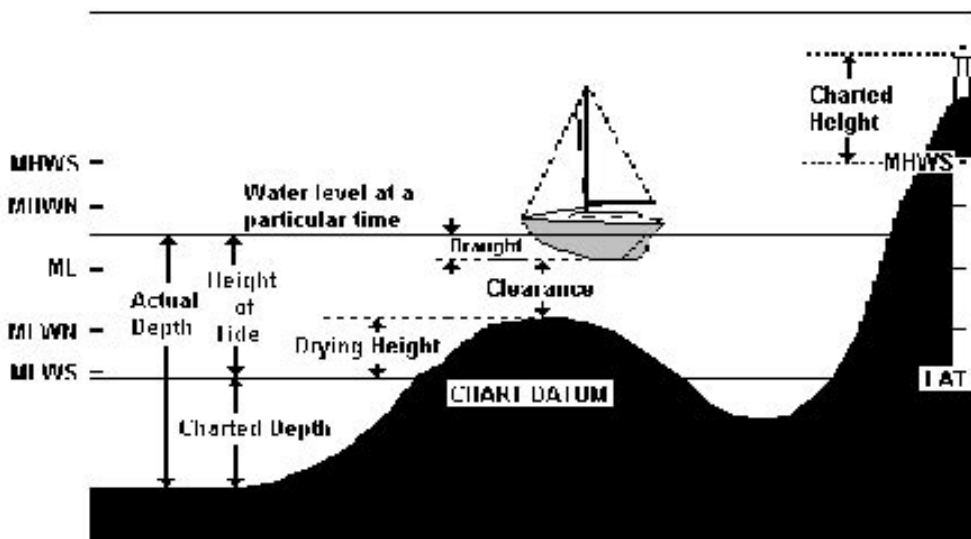

# Distress Signals

When a vessel is in distress and requires assistance, one or more of the following signals shall be used:-

1. A gun or other explosive signal fired at intervals of about one minute.
2. A continuous sounding of SOS by any fog-signalling apparatus.



S O S  
● ● ● — — — ● ● ●

3. Rockets or shells throwing red stars fired one at a time at short intervals.
4. A signal made by radio or by any other signalling method, consisting of SOS.
5. A signal by radio starting with the spoken word - "MAYDAY!"

N

C



6. International Code Flag Signal of distress - NC
7. A signal consisting of a square flag having above or below it a ball.
8. Flames on the vessel - as from a burning tar barrel, oil barrel, etc.
9. A rocket parachute flare or a hand flare showing a red light.
10. A smoke signal giving off orange coloured smoke.
11. Slowly raising and lowering of arms outstretched to each side.



# Distress Signals

Red flares are well known as emergency or distress signals. Anyone seeing a flare will assume that help is urgently required. This means of course that flares must not be used thoughtlessly or “for fun”, as the consequences of setting off a flare may involve many other people, and may include launching a lifeboat, diversion of vessels, dispatch of a helicopter, etc.

Red flares are not fireworks for entertainment or amusement, they are essential Signals of DISTRESS.

## Hand red flare

A hand flare gives a bright red light for 1 minute. It is used within 3 miles of land, or to pinpoint the position of an emergency when help is on the way.



## Red parachute flare

For long range distress signals a parachute flare is used. A rocket projects a very bright flare up to about 1000 feet, and this slowly descends on a parachute, burning for about 40 seconds.

### TIP



*Mis-use of Flares may cost lives. Only use in an emergency.*



## Orange smoke flare

Orange smoke is the daylight equivalent of a red flare. A hand-held signal produces a cloud of orange smoke lasting about 40 seconds.

A buoyant orange smoke signal is dropped into the water after ignition - it floats and produces a cloud of orange smoke for three minutes.



## White flares

White flares are not distress signals - they are used to draw attention to a vessel's position, particularly as a collision warning signal if a vessel on a collision course does not appear to have seen you. White flares are usually only available as hand flares.

# Distress Signals

Most Scout boating expeditions and open boat cruising will be in inshore waters.

When on an expedition always keep your flares readily available in case of emergency - don't keep them packed in the bottom of a bag or under a pile of gear. The recommended minimum numbers and types of flares that should be carried by vessels are as follows -

Inshore - within 3 miles of the coast

2 red hand flares

2 hand orange smoke signals

Coastal - up to seven miles off the coast

2 red parachute rockets

2 red hand flares

2 hand orange smoke signals

## Care of flares

In the boat, store flares in a dry water-proof container if possible, or at least in a plastic bag.

Ashore, store them in a dry place, but well away from heat and naked flames. Flares should not be used if out of date. They have a life of three years and either the date of manufacture or date of expiry will be printed on each flare.

They are expensive items and it is very tempting to keep old, out of date ones. This could be a false economy as an out of date flare may not function properly, or at all. It is also potentially dangerous as flares become unstable as they age.

### TIP

#### *Distress Flares*

- Red Hand Flare
- Red Parachute Flare
- Orange Smoke

#### *Signal Flare*

- White Flare



# Buoyage

IALA Buoys are the signposts of the Sea. Each one has a particular meaning and tells you to go a particular way.

## Cardinal marks

Cardinal marks come in the cardinal points on the compass:- North, East, South and West. And you should pass that side of the mark, for example:- to the North of a North cardinal mark and to the east of a East cardinal mark. They usually mark large areas of danger such as shoals or sand banks but can be used in any situation.

### North cardinal -

Top marks - both points upwards

Colours - black over yellow

Lights - white, quick or very quick flash (continuous)

### East cardinal -

Top marks - base to base

Colours - black on top and bottom, yellow middle

Lights - white, group of three

### South cardinal -

Top marks - both points downwards

Colours - black below, yellow above

Lights - white, group of six flashes, followed by one long flash.

### West cardinal -

Top mark - point to point

Colours - black middle, yellow top and bottom.

Lights - white, group of nine

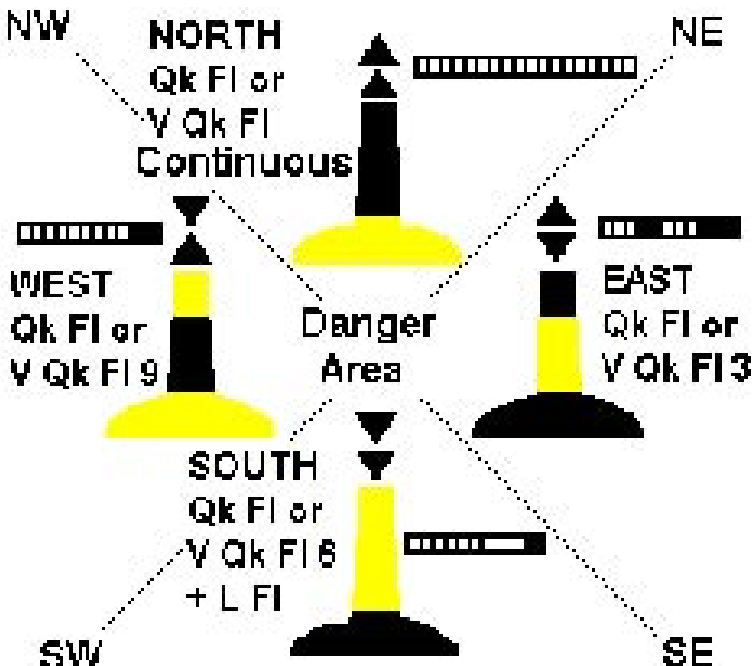

# Buoyage

## Lateral marks

Lateral marks are used to mark channels. You pass these to port and starboard when going into port and in the direction of buoyage.

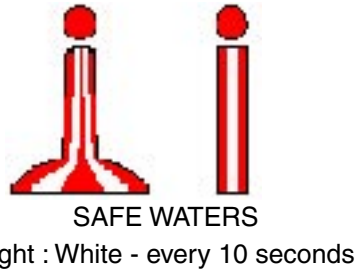
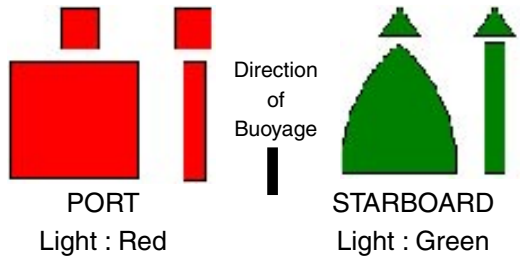

## Safe watermark

These marks are used to indicate the centre of a channel, or the entrance to a wide-mouthed channel. Safe Water marks are red and white vertical Stripes and can be passed on either side. They may be looked on as a form of sign-post and do not mark any hazards.

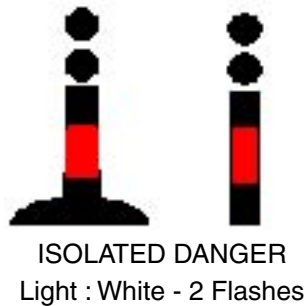

## Isolated danger mark

These are used to mark isolated danger which have deep water all around, such as a small wreck and can be passed on either side.

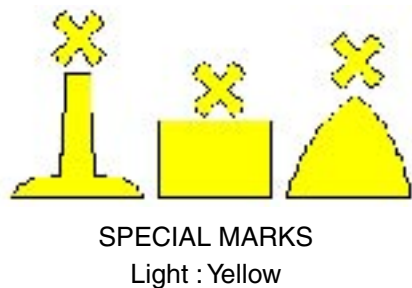

## Special marks

These indicate special areas or features - recreational or military exercise areas, sewage outfalls etc. They do not mark navigational hazards.

# Rules of the Road

The International Regulations for Prevention of Collisions at Sea, more often known as the “Rules of the Road at Sea”, regulate the movement of vessels, so as to avoid a collision. There are a lot of rules, and some of them are very complicated, but you are not expected to know them all, or in great detail. The following is a summary of the rules most relevant to Sea Scouts.

In practice, small boats should try to avoid areas used by large commercial vessels, as it may be very difficult for them to manoeuvre due to their size. All vessels should stay to the starboard side of any channel or fairway she sails through.

## Vessels under oars (canoes & rowing boats)

Keep clear of all other vessels. Canoes give way to vessels under oars



## Sailing Vessels

1. A sailing vessel should keep out of the way of:

- Any vessel she is overtaking.
- Any vessel which is fishing.
- Any vessel “not under command”.
- vessel with restricted manoeuvrability.

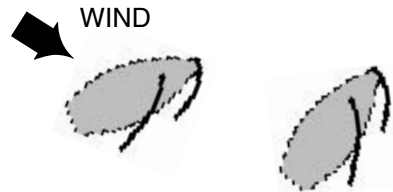

2. When two sailing vessels are approaching one another, so as to avoid risk of collision:

- a vessel with the wind on her port side should keep out of the way of a vessel which has the wind on her starboard side.
- when both vessels have the wind on the same side, the windward vessel keeps clear.

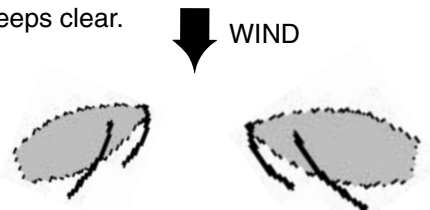

**Note:** For the purposes of the sailing rules the windward side is defined as the opposite side to the mainsail. A vessel with the wind on the port side, unable to determine on which side the windward vessel has her mainsail should give way, e.g. if windward boat is carrying a large spinnaker which obscures the view of the mainsail.



# Rules of the Road

## Power Vessels

1. A power vessel should keep out of the way of:
  - a) Any vessel she is overtaking.
  - b) a sailing vessel.
  - c) vessels fishing.
  - d) Any vessel "not under command".
  - e) vessels with restricted manoeuvrability.



### OVERTAKING VESSEL STAYS CLEAR

2. When two power vessels are approaching head-on, each should go to starboard.



### TWO POWER BOATS MEETING HEAD ON, BOATS STEER TO STARBOARD

3. When two power vessels are crossing, so as to avoid risk of collision the vessel which has the other on her own starboard side keeps out of the way.



## Navigation Lights

This is a summary of the lights & shapes that you are likely to encounter close inshore on the Irish Coast.

### Power vessel under way -

1. Mast lights - white light on the foremast visible from right ahead to  $22.5^\circ$  (two points) abaft the beam, and a similar light on the main mast (unnecessary on vessels under 50 m long). The forward light should be 5 m lower than the after light.

2. Side lights - on starboard a green light and on port a red light, each visible from right ahead to  $22.5^\circ$  abaft the beam on its own side.

3. Stern light - white light visible from right astern to  $22.5^\circ$  abaft the beam on each side.

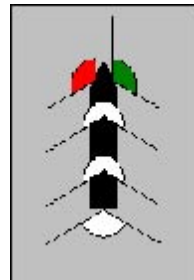

### Small open boats – (most Sea Scout boats)

Under oars or sail a lantern or torch should be carried to display a white light in sufficient time to prevent a collision.

# Rules of the Road

## Sailing vessel under way -

1. Side and stern lights as before.
2. No mast light, except - optional red over green all-round lights on the foremast.
3. A sailing vessel under 12 m may have a tricolour light at the masthead, showing red, green and white in the appropriate sectors, instead of separate side and stern lights.
4. A sailing vessel under sail and under power simultaneously, must show lights of a power vessel by night, and by day must carry a black cone, apex down, in the rigging.

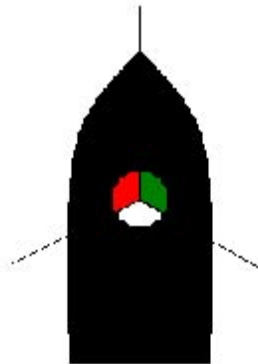

## Fishing vessels

Only when fishing;

1. - a green over a white light (visible all round) for trawling  
- a red over a white light for other types of fishing.
2. Side and stern lights when under way.
3. By day, fishing vessels display two black cones, points together, in fore rigging.

## Vessel at anchor -

1. All-round white light forward.
  2. Vessel over 50 meters long will have another white light near the stern, lower than the forward light.
  3. By day, one black ball in place of the forward light.
- Note:* In practice, very large ships at anchor may also have all deck lights

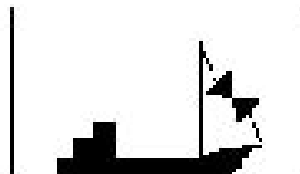
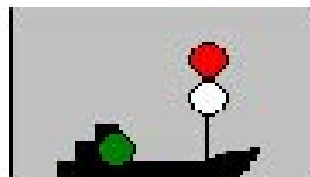
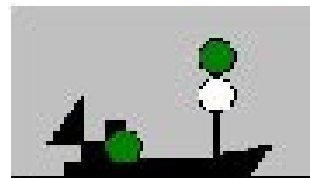

# Marine VHF

These notes are not intended to be complete. They will give you some background information about Marine VHF, but are not sufficient for a restricted operators certificate.

Marine VHF. The International Maritime Band in VHF is divided into 54 “Channels”. You will not be expected to know about all the channels but you should know about the most important ones.



## Characteristics of VHF

VHF radio is quite short ranged. It is usually described as being “line of sight”. The range is influenced by the height of the aerial, and also by the type of aerial. Ship to ship range is probably about 25 miles. Another characteristic is the so called “capture” effect. If two stations are transmitting simultaneously a third (receiving) station will hear only one of them, and not a jumble of both. This means much less distortion or background noise, but a more powerful or nearer station may wipe out the signals of another station.

## Priority of Calls

1. Distress - “MAYDAY” - Imminent danger; immediate assistance requested.
2. Urgency - “PAN-PAN” - Urgent message about safety of ship or person.
3. Safety - “SÉCURITÉ” - Important navigational or meteorological warning.

## Transmission Rules

The following are strictly forbidden:-

1. Operation by unauthorised person - unlicensed person may use under supervision.
2. Transmission of false or deceptive distress, safety or identification signal.
3. Closing down before finishing all operations following distress, urgency or safety call
4. “Broadcasting” messages or programmes, except safety messages, to “All Ships”.
5. Unnecessary transmission or superfluous signals.
6. Transmission of profane, indecent or obscene language.



# Marine VHF

## Using VHF

1. Make sure that the set is switched on.
2. Adjust the “squelch” control until the back-ground hissing noise just disappears.
3. Check power output button. High power is 25 watts. Use low power (1 watt) when close to the station that you are calling.
4. Select the required channel - usually Channel 16 for calling.
5. Before transmitting, listen on chosen channel - do not transmit if in use. Press the transmit switch on the microphone before you speak.
6. Say the name of the vessel or station that you are calling twice or three times.
7. Identify yourself - “This is....(vessel’s name, twice or three times). Note that it is illegal not to identify yourself. At the end of each transmission say
8. “Over”. This indicates that you expect the other station to reply. Release the transmission button.
- 9.

The station which has been called then replies in the same format, nominates a working channel and says “Over”. If you accept the nominated working channel you say “Roger, Channel.....(repeating the number), if not you suggest an-

Both stations then change to the working channel and the call-up procedure is repeated again to establish contact on the new channel. Thereafter it is not necessary to keep on repeating names before each transmission, but the word “Over” should be used at the end of each transmission.

When communication is finished, and you do not expect any further reply, use the word “Out”. It is incorrect to say “Over and out”. Unless there is any special reason to continue listening to the working channel, you should then switch back to Channel 16.

## Making a Distress Call

1. Select Ch. 16 and High Power
2. MAYDAY, MAYDAY, MAYDAY
3. This is “name of boat”  
(Repeat three times)
4. MAYDAY, MAYDAY, MAYDAY
5. This is “name of boat”
6. State your Position  
Problem  
Persons on board
7. I require immediate assistance
8. Over
9. Listen

# Marine VHF

**CHANNEL ALLOCATION TABLE**

<b>CHANNEL NUMBER</b>	<b>USE</b>
16	Distress calls. Hailing. Switch to a working channel when contact is established
67	Small boat safety
9, 11-14, 62,71	Port Operations and Ship Movement
70	D.S.C. (Digital Selective Calling) Sending digital distress and urgency calls automatically. It cannot be used for voice communications.
6,8, 10, 72, 77	Intership Channels
All Others	Public correspondence. May be used by Coast Radio Stations for telephone calls, radio telegrams, navigational warnings, weather forecasts etc.
Channel 37 (M)	Marina Channel is outside the international Maritime band but is allocated for communications between yachts and marinas or clubs, between committee and rescue boats in regattas etc.

Channel 80 (M2)

Also used for marine communications

# Weather Forecasts

One of the most important things you must check before any activity is the weather forecast. The weather forecast may determine whether you can go or where you can go and for how long.

## Using weather forecasts

When you receive a weather forecast you must study it and consider how it will affect your intended activity. Then you must act accordingly erring on the side of safety.

You must be aware that the weather will have different effects on land or on sea activities. A gale that would make it unsafe to go sailing could add a fun dimension to a hike. Each activity must be judged on each occasion and you must be aware of the effect the weather will have on the location. You must also know the effect it will have on the equipment you intend to use and if the members of your Watch are experienced enough to cope with it.



**Weather on the radio**  
Shipping forecasts

## Wind against tide

Wind blowing against the tide or against the flow of a river or estuary, can make the sea very choppy and rough enough to be dangerous to a small boat or canoe. The same applies to lakes if the wind is against current. This can happen when the weather forecast is not necessarily bad.

## Features

Be aware of the effect of other geographical features in your normal boating waters and where shelter may be found from winds of different directions



**Weather on the Web**

# Weather Forecasts

## Beaufort wind and sea scales

This is the normal and very useful way of describing wind strength and its effects on sheltered waters. It was originally described by Admiral Beaufort, Hydrographer of the Royal Navy in the 19<sup>th</sup> century who was born in County Meath. The scale is from zero (calm) up to twelve (hurricane). Force 8 is known as Gale Force, but Force 6 is often called the small boat gale. Generally Scout boating should not take place if the local wind is greater than Force 4. The following details will help to identify the wind strengths

For wind strengths above Force 1, up to and including Force 8, a simple rule-of-thumb formula may be used to convert Beaufort Force into average wind speed, and vice versa. Examples – (Force x 5) - 5 = Knots      (Knots + 5) ÷ 5 = Force  
 (Force 5 x 5) = 25 - 5 = 20 kts      (15 Kts + 5) = 20 ÷ 5 = Force 4.

Force	Name	Speed (Knots)	Sea State	Land State
0	Calm	<1	Mirror smooth	Smoke rises vertically
1	Light air	1 to 3	Ripples on water	Smoke moves but not on a wind vane
2	Light breeze	4 to 6	Pennant moves	Very small waves. Felt on face. Leaves rustle
3	Gentle breeze	7 to 10	Light flag extends, Crests on small waves	Leaves and twigs move, flag extended
4	Moderate breeze	11 to 16	Small waves with some white horses.	Small branches move, paper lifted
5	Fresh breeze	17 to 21	Moderate waves with many white horses	Small trees begin to sway
6	Strong breeze	22 to 27	Large waves with white foam crests everywhere	Large branches move, umbrellas difficult to use
7	Near gale	28 to 32	Sea heaps up with white foam blown into streaks for breakers	Whole trees move, difficult to walk
8	Gale	33 to 40	Sea very rough and disturbed with well marked streaks of foam	Twigs break off, very difficult to walk



# Weather Forecasts

## Natural Weather Signs

In many parts of the country experienced boatmen or fishermen can often tell from various natural signs that the weather is going to be fair or bad. Many of these signs depend on local knowledge - a combination of appearance of the sky, visibility of landmarks, direction of wind, etc. If there are any such well recognised signs in your area you should try to find out about them, and perhaps keep a particular record of the weather during and following these signs to see if they are true or not.

Most well known rhymes about the weather are of absolutely no value at all. Some rhymes have developed from observations in certain areas, but when taken to another area, or when applied to the country in general, do not work. Never rely on them and always get a weather forecast.

A BP 18's State	Force
A BP is stationary in the water making no progress	0
A light boat starts to move very slowly, but sailing is not very interesting or exciting	1
A BP 18 moves along slowly, but does not heel over.	2
A BP 18 moves much better, heeling a little, but not requiring the crew to "sit out" for balance.	3
Gives a good exciting sail, heeling over with the crew sitting out. If the crew is light you have to consider reefing.	4
Is getting too strong for comfortable sailing and you must reef or shorten sail.	5
Is the " <b>Small Boat Gale</b> " and you should not be out sailing in winds of this strength. But if the wind should increase unexpectedly to this strength, you will certainly require to shorten sail. You may even have to drop the mainsail and sail under jib and mizzen.	6
	7
	8

# Weather Forecasts

## Mountains

Mountain areas create their own localised weather patterns; as the wind moves up a mountainside it cools down. Known as the lapse rate, this can be as much as 1.0°C for every 100 metres of altitude.

Not only will the temperature drop, but as it cools the water vapour in the air will turn to rain. In fact it rains 3 times more in mountain areas. Also the wind in mountain areas is effected by topography and can be funnelled either over or around obstacles. This can be very noticeable in a saddle, a col or on a ridge. When you stop for lunch pick a spot out of the wind such as on the lee side of a mountain or behind a crag and put on a fleece or your wind proof jacket.

## Wind chill

The movement of air greatly increases the cooling effect on the body. This phenomenon is known as wind chill and may occur afloat or on land. Even small changes in wind speed can have a profound effect on the degree of cooling. To prevent heat loss the priorities are to get out of the wind, stay dry and cover as much of your body as possible (hat, gloves etc.). Still air is a good insulator against heat loss so air trapping garments and a layered approach to clothing should be used.

## Getting weather forecasts

Weather forecasts can be had from any of the following Sources:

- Radio (RTE Radio 1)
- BBC Radio 4
- Television
- Harbour Master
- Newspaper
- World Wide Web
- Telephone
- Met Eireann

## Wind Chill Wind Force

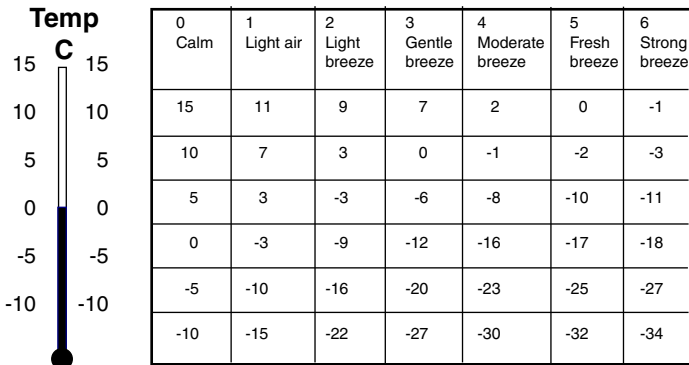

This chart shows the effects of wind chill. If for example the air temperature is 5°C and there is a light breeze, the wind chill equivalent will be minus 3°C. In Mountain areas temperatures are often lower than this and wind speed stronger which can make it feel extremely cold when the wind chill factor is taken into account.

# Maps

## Understanding maps

Being able to interpret the information on a map and relate it to the terrain around you is the most important part of mountain navigation.

## Conventional Symbols

The newest maps in Ireland are made at a scale of 1:50,000. This means that 1cm on the map represents 50,000 cm (500m) on the ground.

2 cm = 1km or 2 mm = 100m

The grid lines on the map are 2 cm apart representing one kilometre.

A map is a bird's eye view of an area where roads, houses, forests, lakes and so on are represented by lines, colours and symbols. By just taking a little time to look at your map closely you will get a lot of information. The signs used to represent objects are given in the key or legend. They change from map to map depending on the scale of the map and its intended use. Some features may be left out while new features will not be represented such as newly planted forest, tracks etc.

While a map is flat, the ground is hilly. There are several ways we can tell the shape of the landscape from the map.

**Colour** - rivers, lakes and the sea are blue, while low lying ground is green and mountains varied shades of brown, getting darker towards higher ground.

Colour gives a good general over view but is of little use for accurate navigation. In some places spot heights are used particularly for summits, knolls etc, that is, the height in metres is printed on the map.

## Setting a map by eye

We set a map to help us relate the map to the terrain. It simply means turning the map around until it coincides with the countryside around you.

Where the visibility is good or the terrain is familiar it is easy to set a map by simply identifying points on the ground and on the map, then rotating the map until it matches the countryside.

An experienced hill walker gets into the habit of having the map set all the time as it helps to identify features, visualise the route ahead and generally avoid getting lost as with the map set feature recognition both near and far becomes easier.



# Maps

**Contours** are imaginary lines following the surface of the ground at the same height.

The most important part of map reading is being able to tell from the map contours what the actual shape of the ground is like.

The shape of the contours will tell you the shape of the ground, while their spacing will tell you its steepness.



Where the contour lines are close together the slope is steep and where they are far apart, the gradient is gentle. Contours will, therefore, enable you to select the least tiring route up a mountain and will warn you if the ground is too steep.

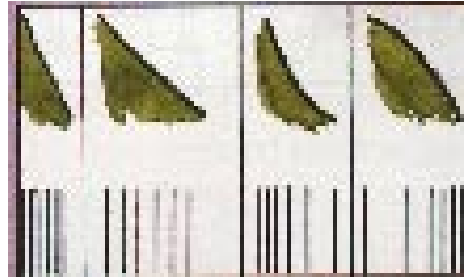

- Cliffs are not marked with a symbol on the 1 : 50,000 OS maps as this would obliterate the contour detail.
- The interval between contours is 10 metres.
- To calculate height, every fifth contour (the index contour) is printed heavier and occasionally the height in metres is printed along the contours.

## TIP



***Use the magnifying lens on your compass to show up the fine detail in the contours.***

# Maps

## Grid references

Using the numbered grid printed on the map we can get a set of co-ordinates to pin-point any place, whether it has a name or not. The National Grid divides Ireland into 25 zones, each of which is sub divided into 100 one kilometre squares which you see on the map.

## Giving a Grid Reference

A grid reference consists of a letter identifying the zone (as occasionally parts of several zones appear on the one map) followed by 6 numbers.

Give the grid numbers from the bottom of the map before those at the side. To pin-point a location we need to divide the grid squares into tenths.

This can be done by eye or using a roamer found on most Silva type compasses or on a navigation card.

For your convenience the grid numbers are also printed across the map so that you can give a reference even when the map is folded in a map case.

## Tips

- If you are in doubt, an example is given on the map.
- Remember you have to go in the door before you can go up the stairs.

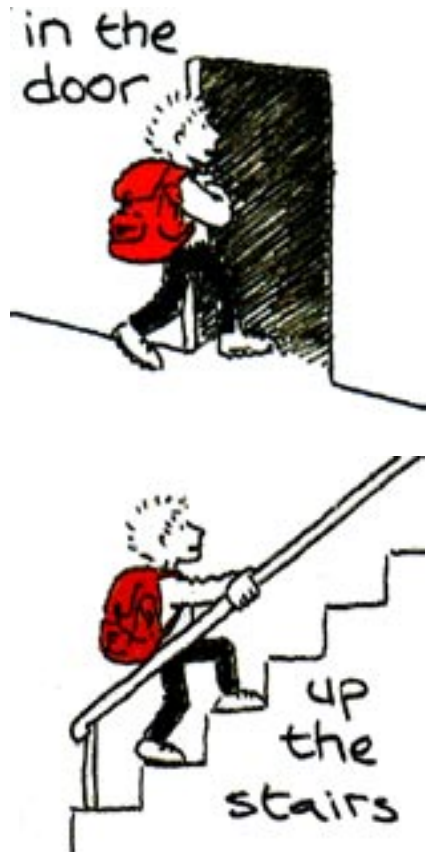

- Use the roamer on your compass or navigation card to divide the grid square into 10ths for more accuracy.

# Compass

## The Silva compass

The protractor type compasses such as those made by Silva are light, reliable and accurate for mountain navigation and with their see through base plate are ideal when used in conjunction with the map. Its main features are:-

- The compass dial is a 360° protractor used for calculating angles known as bearings
- Measurements for calculating distance on the map.
- Parallel orienting lines and orienting arrow used to align the compass dial with the North - South grid lines on the map when getting a bearing.
- The magnetic needle  
The red end points to magnetic north
- Roamers for several scale maps used to help give accurate grid references.
- Direction of travel arrow points the way you have to go when following a bearing.
- Magnifying lens to help with map detail.
- Index Marker (where the tail of the direction of travel arrow cuts the dial). This is where you read your

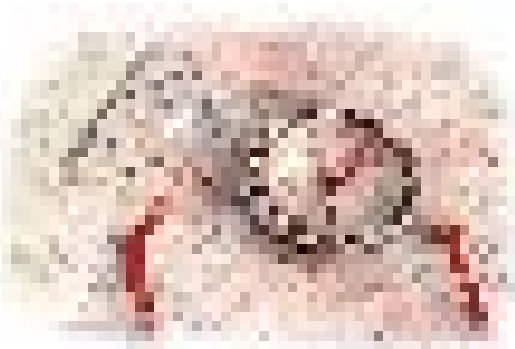

## Setting a map by compass

In bad weather or in unfamiliar or featureless country, using a compass is the only reliable way to set your map. Again, the purpose is to orientate the map so that it coincides with the countryside around you and will make route finding and feature recognition easier. To do this, simply place the compass on the map and, while holding it flat, turn both the compass and the map until the red end of the magnetic needle points to north on the map. The map is now set.

### TIP

- *Your compass should be attached to your jacket or rucksack on a boot lace, long enough to allow you to use the compass with the map to calculate a bearing.*
- *When using your map and compass out in the open, get down on your hunkers and shelter it from the wind.*



# Getting A Bearing

## Magnetic variation.

Using a map and a compass together is complicated by the slight difference between north at the top of the map and shown by the grid lines on the map (Grid North) and north indicated by the magnetic needle of the compass (Magnetic North) which points to an area of magnetism caused by the earth's rotation. This difference is called the magnetic variation and varies from place to place as well as with time. It will be given on the map for that particular area.

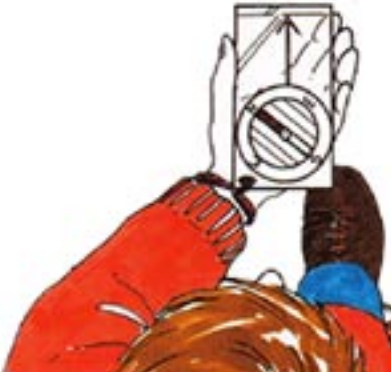

## Taking a bearing.

A bearing is the angle between the direction you want to travel and North. The compass dial is basically a protractor to help calculate these angles using the north south grid lines on the map as a baseline i.e. north is  $0^\circ$ . So if you are walking towards the North East you are

## To calculate a bearing.

- Place the edge of your compass along the line you want to travel making sure that the direction of travel arrow points to where you want to go.



- Rotate the compass dial until the orienting lines in the dial are parallel to the North - South grid lines on the map, making sure that the N on the dial points to the North on the map. The direction of the compass needle does not matter because you are only using the compass as a protractor. The grid bearing can be read at the index marker where the compass dial is intersected by the direction of travel arrow.





# Walking on a Bearing

- To convert this grid bearing into a magnetic bearing which you can walk on, add the magnetic variation by turning the compass dial the appropriate number of degrees for that area. WHEN GOING FROM 'GRID' TO 'MAG' YOU ADD



- Holding the compass flat in the palm of your hand, turn round until the magnetic needle lies on top of the orienting arrow (the red end of the magnetic needle pointing to the N on the dial). Then walk in the direction shown by the direction of travel arrow.

## Walking on a bearing

Whenever possible select a point ahead which is on the route (a boulder, a hilltop) and walk towards it instead of continuously looking at your compass. When that point is reached or can no longer be seen, take up the compass again, with the same bearing and find a new point ahead. Repeat this until you reach your destination.

## Tips

- When calculating bearings roughly figure out what it should be by just looking at the map, i.e.,  $35^\circ - 40^\circ$  so that you will know if you make an error when using the compass.
- Common errors include aligning the orienting lines in the dial with the wrong gridline on the map. Or by placing the compass on the map with the direction of travel arrow pointing in the opposite direction to the way you want to go.
- Walking straight on a bearing often leads through rough ground, and unnecessary ups and downs. If the visibility is good it is usually easier to walk and navigate by following line features or 'handrails' (ridges, streams, etc.) and by careful reading of the contours rather than by bearings.

# The Sky at Night

## The Sky at night

Even without a map and compass you can still find your way at night using the stars as your guide. The best constellation to use is Ursa Major (The Great Bear), often called the Plough.

The pair of stars called The Pointers point directly to the North Star, "Polaris", when you face Polaris you are looking North, East is on your right, South behind you and West will be on your left.

Another star constellation which is useful in finding North at certain times of the year is Orion (The Hunter). If you imagine a line running from the middle star of Orion's Belt and through the group of smaller stars which forms his head, this line also points to the North Star.

## Tips

These two constellations can also be used as signposts to spot other constellations. Use the Pointers of the plough the other way to find Leo (The Lion).

The plough's handle points to Bootes (The Ploughman) and Corona Borealis (the Northern Crown). Use the pointers on the plough to find Polaris and you have also found Ursa Minor (The Little Bear), and if you continue the same distance past Polaris you'll easily find the W shaded constellation of Cassiopeia.

Follow the line formed by the three distinctive stars that make up Orion's belt to the left to find Canis Major (The Big Dog) which has the brightest star in the northern skies (Sirrius). To the right of Orion's belt is the distinctive v-shaped constellation of Taurus (The Bull) and a star group called Pleiades (the Seven Sisters).



# Identifying A Feature

If something is obstructing your chosen route you will have to go around it without losing your bearing. If you can see across it there is no problem. Just take a bearing on some landmark on the other side and walk around until you reach it and continue on your journey. If you can't see over the obstacle, then you will have no option but to go around it in a series of right angled legs to be certain you come back on line on the far side.

## Back bearings

Back bearings are useful if your destination goes out of view or becomes obscured by mist or cloud, but your point of departure is still visible.

To check you are still on your bearing simply point the compass at your point of departure and the southern end of the compass needle should cover the red orienting arrow in the compass dial if you are still on course.

If not, correct yourself by walking a little to the right or left until the needle lines up and then continue along your original bearing

**Identifying a feature** - Magnetic to Grid

The map does not need to be set - but by setting the map you may be able to identify the feature straight away.

## Using your compass

### Stage 1

Calculate from the countryside the magnetic bearing between your position and the feature to be identified. To do this:-

a) Point the compass directly at the feature you wish to identify.



b) Turn the compass dial around until the red orienting arrow lies directly under the red end of the magnetic needle. (Put the red to bed)

c) The magnetic bearing is given at the index marker where the direction of travel arrow meets the compass dial.

d) Convert this magnetic bearing to a grid bearing by subtracting the Magnetic Variation. MAG TO GRID, GET RID

# Cross Bearings

## Stage 2

To identify the feature on the map:-

- a) Place the long edge of the compass on your position on the map.



- b) Pivot the whole compass around this point until the orienting lines in the compass dial are parallel to the north-south grid lines on the map, making sure that north on the compass dial points to north on the map.



- c) The same edge of your compass should pass through the feature you are trying to identify.

## Tips

Some compasses have long parallel lines in the base plate. These may be easier to use than the edge of the compass.

## Cross bearings

If you are not sure of your exact location you can use bearings to pin point your position. Identify at least two features which you can locate on the map. Using your compass take a magnetic bearing on each feature. Convert these to grid bearings by subtracting the magnetic variation. (Mag to Grid get Rid). Plot both bearings on the map and where they cross should be your location.

More accuracy is obtained by taking three bearings and plotting the three lines on the map. Then your position is somewhere in the triangle where the three lines almost meet. If the triangle is large check the features and bearings.

If you are along a line feature such as a stream or ridge but do not know exactly how far along it you are, you can pinpoint your position by taking a single bearing on an identified feature and then plotting this on your map. Your position is where the plotted pencil line crosses the line feature



# Route Planning

## Route Card

Before setting out on any hill walk or expedition, you should always fill out a route card. They look a bit complicated at first, but are important:

- To estimate the length of time for the expedition, and see if it's suitable for the age and ability of those involved.
- To act as a checklist during planning.
- To have on hand, during the route, a set of carefully calculated times and bearings for accurate navigation in rough terrain or in bad visibility.
- To have on hand information regarding group members, gear, weather etc.
- To leave a copy with a responsible person for use in an emergency

## To make a route card

Break your intended route into logical stages or "legs". For each location get its grid reference and work out the magnetic bearing for each leg. Then work out the time it will take to walk.

## This will depend on 3 things:-

1. The height climbed (you can work this out from the contour detail on your map). Each contour represents 10m. For every 10 metres climbed, allow 1 minute.
2. The distance to be walked. You can figure this out from the map. Each grid square is 1km wide on the 1:50,000 OS maps (2cm = 1km 2mm = 100m).
3. You need to estimate the speed you walk at. You can only guess this from experience as it depends on your fitness, age, weight of pack, type of terrain etc.

## Estimate your walking speed

2km/hr, then 1km = 30 minutes  
(100 metres = 3 mins)  
3km/hr then 1km = 20 minutes  
(100 metres = 2 mins)  
4km/hr then 1km = 15 minutes  
(100 metres = 1.5 mins)  
5km/hr then 1km = 12 minutes  
(100 metres = 1.2 mins)  
3 km/hr is a good average for a beginners group carrying packs

## Example

Allow about 10 minutes per hour for rests and some time for lunch.

# Route Planning

Work out these calculations on a piece of card in the comfort of your own home before the hike. Then take the route card with you, placing it in a waterproof map case.

If the leg of your route is 1km long and has a height gain of 150m it will take you 20mins for the distance if you walk at 3km per hour and 15 mins for the height climbed. Total time 35 mins.

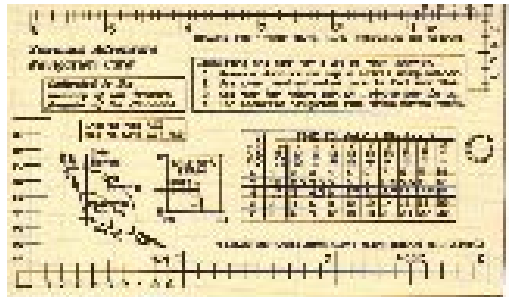

START	GRID REFERENCE							
		1 BEARING / FEATURE	2 FACE	3 DISTANCE IN METRES	4 HEIGHT CLIMBED IN METRES	5 DISTANCE TIME	6 HEIGHT TIME ALLOWANCE	7 WALK TIME
TOTALS								
ETA								

## In case of emergencies

Work out suitable escape routes in case of bad weather or if you have a incident en route. Keep them simple and easy to understand in case of an emergency, e.g., head east to farm house.

# Navigation Techniques

## Coping with Terrain

The map will not tell you what the ground is going to be like under foot. It could be boggy, scree or thick heather. Heavy packs can make steep terrain much more difficult to cope with. Climbing with a full load can be tiring and needs to be taken slowly at a steady pace. Zig Zag up and down steep slopes. Always keep your map handy and orientated and never pass up a good opportunity to confirm your position

## Group leadership

When leading a group ensure you walk at the pace of the slowest member and stay together. That way every one will benefit from rest stops as well as being involved in the group's navigation.

Appoint someone experienced to bring up the rear who can ensure that no one is being left lagging behind and occasionally check that you are still on your bearing. The group splitting up and not staying together is one of the main reasons for mountain rescue callouts and fatalities in the Irish hills.

## Linear features

It is sometimes possible to locate your position along a linear feature such as a stream by its direction. This can be done by either setting the map or by taking a bearing along a section of it and comparing this with the map.

This is also of use to confirm you are at the correct river junction. Take a bearing of each branch and compare these with the river junctions on the map.



## Attack-points

Attack-points are used when navigating to an isolated spot. The attack-point is the nearest or most obvious "dead fix" point which can be reached comparatively easily. Once at the attack-point orientate the map and work out the exact location of your target destination using fine navigation i.e., timing, pacing and compass bearings. The river is used as a hand rail until the distinctive bend is reached (the attack point) and from there use fine navigation to get to the isolated hut.



# Navigation Using A Map

## Handrails

Any linear feature such as a stream, path, earth bank or forest boundary can be used as a handrail to guide you to your destination. Although this may sometimes be longer it is more reliable way of getting to a target as it reduces the amount of open ground that has to be navigated. Here the route follows a stream, a path and then skirts along the forest edge.



## Contouring

Contouring is another name for keeping height by walking along a contour. This way you can avoid needlessly climbing height or losing any that you have already gained on route. Cutting across a 'valley' may seem like a short cut, but you lose height and then you end up having to climb a steep slope to regain it.



From a distance a steep slope can look deceptively easy. It may take longer but it is more energy efficient to contour. But in bad weather it is difficult to stay on course as you can not follow a bearing.

## Aiming-off

This is a technique used to navigate to a linear feature, such as a stream junction, when you cannot see it. This is done by deliberately aiming off to one side so you know which way to turn to find it when the river is reached. Circumstances will dictate whether to aim to the left or right, e.g. keeping height. Here we have aimed off to the left keeping height. When the river is reached we know we have to go down stream (turn right) to find the junction



## Tickoff features

Practise memorising short legs of your route by building up a mental picture of the features you should encounter: col, forest edge etc. If these fail to appear, then check you're going in the right direction. In poor visibility use every opportunity to reconfirm your position.

## Overshoot features

From the map, you should be able to see what happens should you overshoot your intended target, i.e. a change in slope, a stream etc. Forest edge, road, stream, steep uphill slope to the summit. Once you start to lose height you know that you have gone too far and have overshoot your target.

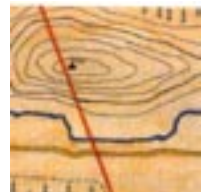

# Sending for Help

## Sending for help

It is usually a combination of factors that cause an emergency, i.e. bad weather and an injury. Don't send for help unless you are sure you need it. As a general rule, the party should always stay together. Planning a route beforehand can help by ensuring you don't tackle a route beyond the ability of the group. Help with identifying escape routes and potential obstacles such as rivers and ensuring that the correct equipment is carried. A copy of your route card should be left with someone reliable who can contact the mountain rescue services should you fail to turn up a long time after your estimated time of arrival (ETA).

## When sending for help

Check your position.

Send at least two people for help if you can.

From your route card which you prepared at home, you should have identified escape routes to use in such a situation.

Before setting off, write down your grid reference and some brief details of the accident, the casualty's name, injuries, the time of the accident and treatment given.



It's a good idea to have a record card for this purpose as part of your first aid kit.

Do not be reluctant to call out the mountain rescue services (via the police, by dialling 999 or 112 from a mobile).

While waiting for the rescue team do what first aid you can to make the casualty warm and comfortable, guard against hypothermia and further deterioration.

Make sure everyone else is warm and secure.

## TIPS

Many hillwalkers include a KISU Group Shelter as part of their group equipment. This is like a large fly sheet under which the group can huddle to keep warm.

- Consider whether you should bring a mobile phone. Keep it dry to ensure dampness does not short the batteries. You may need to change your location to higher ground in order to make contact in mountain areas.
- Some people bring a small flare as part of their group equipment.

# Inland Waterway Navigation

Ireland has many rivers and lakes which are ideal for Sea Scouting. Some of these waters are formally recognised as Inland Waterways and these are the ones that we will deal with in this section. Many of them are linked together to make an extensive system to explore and to use for adventure journeys and waterside camps.

It is difficult to manage a sailing craft if the current is fast and especially if the banks are high or have high or overhanging trees. Sailing can very pleasant on a slow moving river with flat surrounding countryside, but if you are used to sailing on wide, open water, you will find sailing on a winding river quite different.

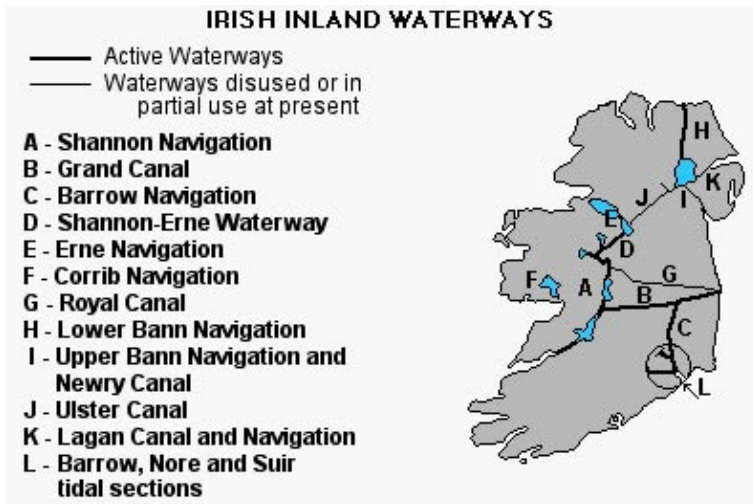

The basic rules of boat handling and water safety apply equally to inland waterways as to the sea. Of course you do not have tides to consider, but you must not forget that rivers will rise and flow more rapidly after heavy rains.

When planning a river expedition by canoe or rowing boat you will probably choose to go downstream. Most rivers are not suitable for sailing.

On a still-water canal there is no problem going either way. Most craft on a canal will be under power, but it possible to get permission to use rowing craft or canoes. In general, sailing is not allowed on canals. All maintained Inland Waterways are under the control of some authority and have bye-laws. When planning an activity on a waterway, Scouts must find out what are the local bye-laws and what are the charges for permits and/or for lock usage.

# Inland Waterway Navigation

## Boat Handling on Inland Waterways

Many of the “steering and sailing” rules which are used at sea are also used on the inland waterways, especially on lakes.

- Power craft give way to sail.
- Sailing craft on different tacks – port tack must give way.
- Sailing craft on same tack – windward boat must give way.
- Power vessels crossing – vessel with the other on his starboard (right) must give way.
- When two vessels are approaching each other, bow to bow, both should steer to starboard (right) and pass each other on the port (left) side.
- In a narrow channel keep to the right.
- Overtaking vessel must stay clear of vessel being overtaken. When overtaking in a narrow channel, canal or river, leave the vessel being overtaken to starboard (right).

There are also some special rules applying to inland waterways -

- At a bridge, vessel going upstream must give way to a vessel coming downstream.
- Approach a lock slowly and give way to vessels exiting.

## Navigation Marks

Shannon Navigation - In the river sections and in the lakes, the marking system used is Red to the left (port) and Black to the right (starboard), when going upstream or into bays or harbours.



Perches (markers on a post or pole) are red, round shaped to the left, or black square shaped to the right. Marker buoys may be can-shaped or conical - the shape is not important, but pay attention to the colour.

Lough Erne Navigation - Perches are semicircular in shape, flat top to port and round top to starboard when going upstream. Also, the marks are coloured red/white vertically, the red on the side of danger, white on the safe side.

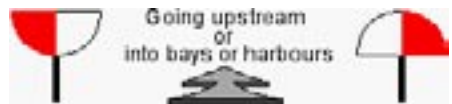

## Lough Corrib Navigation

Going upstream from Galway to Cong, all port hand marks (buoys, perches or beacons) are black, starboard hand marks are red (perches) or white (stone beacons). This is the opposite to the usual convention.

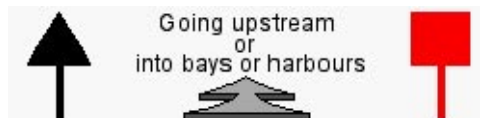

# Inland Waterway Navigation

## Operating a lock

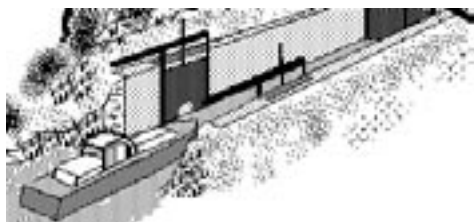

**Ascending** There are no steps or ladders in locks on Irish waterways and a crew member should be put ashore below the lock before entering, to take the lines and help operate the lock. If the lock is empty open the lower gates, the boat can enter the lock and tie up. If the lock is full, it must be emptied. The crew remaining on the boat must beware of the turbulence that will be caused by the outflow of water and should keep the boat clear.

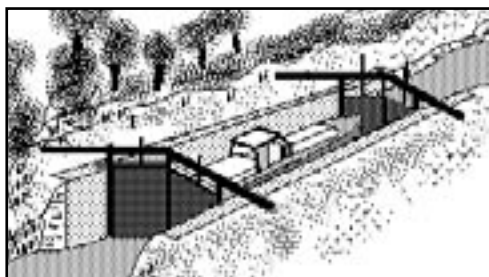

Sometimes there is a lock-keeper, but often the crew will have to operate the lock themselves. On the Shannon-Erne Waterway the locks are operated electronically by the boat's crew, using a "smart card".

The lower gates are closed and the racks on the lower gates are lowered to close the sluices. When filling the lock, take care to avoid too much turbulence which might push the boat about in the lock. Raise the rack on the opposite side to the boat, about half-way at first, then after a short time, raise the second rack, also about half-way. When the water level is about one third way up, raise both racks fully. The bow and stern lines must be tended and kept taut to keep the boat under control.

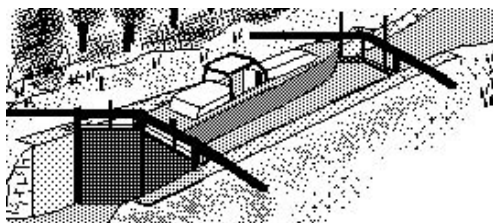

When the water levels on both sides of the upper gates are equal, the upper gates can be opened easily and the boat can move out onto the upper level. The upper gates and sluices should be closed. This will minimise leakage from the upper level and wastage of water.

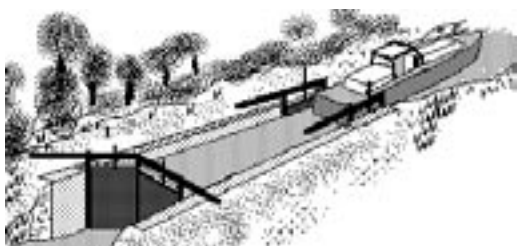

# Marine Compass

## The Magnetic Compass

The Magnetic compass was first used when people discovered that a piece of magnetised iron, if suspended or balanced, would point towards the north. In fact it does not point towards the North Pole, which would be **True North**, but does point towards the Magnetic Pole, in the Arctic regions of Canada, giving us **Magnetic North**. The difference between Magnetic North and True North is called the **Magnetic Variation** and changes by a small amount every year, as the location of the Magnetic Pole moves slightly all the time. Details of the local magnetic variation are printed on every nautical chart and Ordnance Survey map for the year they were published.

The essential part of a compass is a magnetic needle. Because of this you must not allow any other magnets or objects containing iron or steel near the compass as this will affect the accuracy of the compass. Interference caused by such metal objects or magnetic fields near the compass is called **Compass Deviation**.

Most Sea Scouts will be familiar with the “Silva” Compass, used mainly on land for hiking or orienteering. This type of compass can also be used on small boats and canoes if taped down in front of the helmsman and placed right on the centre line of the boat with the arrow facing right ahead.

To use a ‘Silva’ type compass which has been fitted to your boat, turn the bezel line up the course you want to steer with the index mark on the dial. Alter your course so that the **red** half of the magnetic needle lines up with the north pointing arrow. When they are lined up, the boat’s head is in the direction you want.





# Marine Compass

Modern compasses use 360° notation and mark North, East, South and West, the cardinal points. Before 360° notation was used, people referred to the compass points for navigation.

Nowadays the only use for cardinal and intermediate points is for wind direction, when the direction given is the direction the wind is coming from, and tidal streams, when the direction given is the direction the tidal stream is going.

Compass courses and bearings are always given in degrees, using three figures. For example, 'North East' is written as 045°, and would be spoken as 'zero four five degrees' while south is 180° and spoken as 'one eight zero degrees'.

A **Course** is the direction you in which are going to travel.

A **Bearing** is the direction of one position from another. It is possible to get a rough bearing with a Silva type compass.



Other types of compass designed for marine use are available and are fitted to larger vessels. These are very expensive and not suitable for use in small boats.

Also available is a hand-bearing compass, which will have some form of sighting device which can be used to take more accurate bearings.

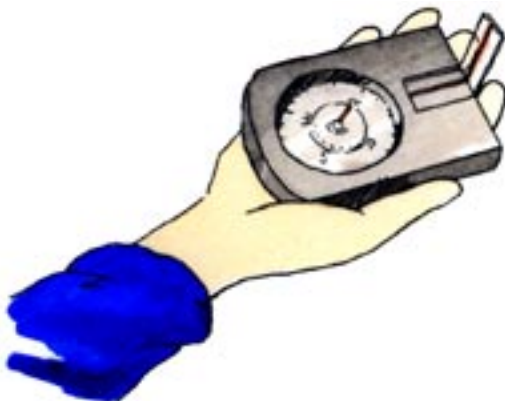

# Coastal Navigation

In land navigation, we use the National Grid to define position. In sea navigation **Latitude** and **Longitude** are used

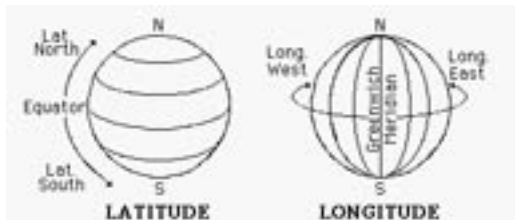

The lines of Latitude, or “parallels”, run around the Earth, parallel to the Equator. They are designated by their angular distance (as measured from the Earth’s centre) up to 90° North or South of the Equator. The latitude scale is on the east and west sides of a chart. Each degree is divided into sixty minutes

The lines of Longitude, or “meridians”, run North/South, from pole to pole. They are designated by their angular distance up to 180° East or West of the meridian which runs through Greenwich, near London. The longitude scale is on the top and bottom margins of a chart.

Latitude is also used to measure distance. The distance on the surface of the earth represented by **one minute of Latitude** is known as a **Nautical Mile** or **Sea Mile**, which is divided into **10 Cables** (one cable = approximately 200 metres). Six Sea Miles is about 7 Land Miles. The latitude scale on either side of the chart is used as a distance scale. In the diagram below, the divider is measuring a distance of 3 nautical miles.

**Speed** is expressed in nautical miles per hour. One nautical mile per hour is called a “**knot**”.



**NEVER use the longitude scale (top and bottom of the chart) to measure distance!**

## Chart Symbols

Like the Ordnance Survey maps that you have already learned to use, charts use symbols to represent different features. Charts show lighthouses, navigation buoys and their lights, shoals, sandbanks and rocks, as well as features on the land which can be useful for coastal navigation. A selection of various symbols commonly used in Admiralty charts is given on the following page.

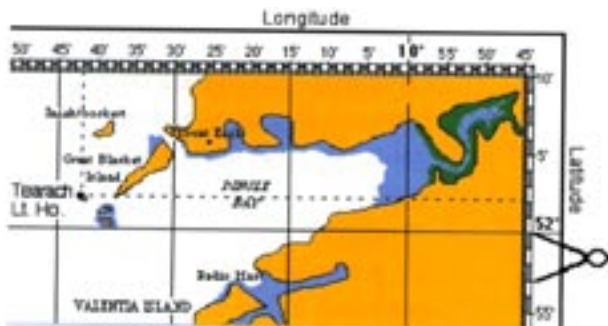



# Coastal Navigation



## Depths and heights

On a land map the height of the land is important, but on a chart the depth of the water is important. All over the sea areas of the chart you will see figures indicating the depth of water in metres. In shallow water there is often a small figure after the ordinary size figure – e.g. 3<sub>3</sub>. This means a decimal – 3.3 metres.

Because of the regular rise and fall of the tides, the depth of water is continually changing. The **lowest low tide** that can be calculated is the level from which the soundings are measured, so the water depth marked on a chart is

the least depth that can usually occur at that place. In the green areas of the chart, covered by high tide, but exposed at low tide, the figures are underlined, indicating height **above** the level of lowest Low Tide. They are called **Drying Heights**. For example, 1<sub>7</sub> means that this spot will not be covered by water until the tide has reached 1.7 metres.

Heights of land, hills, islands, rocks which never cover, lighthouses and beacons, as well as clearances under bridges or overhead cables, are measured from the height of High Water Springs.

# Coastal Navigation

## Plotting Position

Take a bearing on something you can see clearly and can identify on the chart (eg. lighthouse). Line the **parallel ruler** through the bearing mark on the outside ring and the centre of the compass Rose. "Walk" the ruler across the chart making sure that it does not slip, until the edge touches the symbol of the lighthouse on the chart. Draw a line on the chart along the edge of the ruler from the lighthouse. Your position is somewhere on that line.

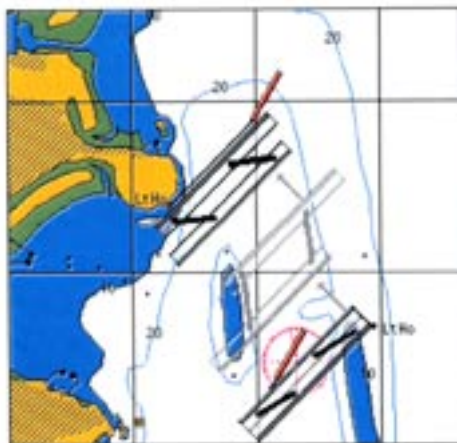

The **Breton Plotter** has a rotating dial in the middle which acts as a mobile compass rose. Rotate the dial until the correct bearing is at the zero mark at the end of the instrument marked with an arrow. Make sure that the North mark on the dial is pointing to the north of the chart and that the grid lines in the centre, line up with either latitude or longitude lines on the chart. Keeping these in line, move the instrument until the edge touches the Lighthouse. Then draw in the bearing line.



# The Environment

## The Environment

Our mountains and wilderness areas form part of a sensitive environment, under pressure from a whole host of activities and interests of which back-packing is only one.

Even remote mountain areas are part of a working environment and are often used for extensive grazing by a group of farmers. Ensure that your presence is unobtrusive and does not interfere with farming, forestry or gamekeeping activities.

## Walls and fences

Use gates and stiles even if this entails a short diversion. Leave all gates as you found them.

If it is necessary to climb a wall, do so carefully and replace any dislodged stones.

If you need to climb a fence do so at a straining post which is the strongest part of the fence.

Keep to footpaths across enclosed lands and avoid entering farm land containing livestock. Take extra care during sensitive periods such as the lambing season.

## Litter

- Plan to minimise rubbish, particularly on overnight trips i.e. repack food into lunch box containers and leave excess packaging at home.

- Bring all your rubbish home: It is useful to carry a plastic bag for this. Don't bury or throw it behind rocks, animals will dig it up!! Don't bury it in snow, it soon reappears!!



## S.O.S.

S.O.S. or Save Our Seas should be your catchphrase. For years, the seas and oceans and to some extent rivers and lakes have been used as a dumping ground for all sorts of rubbish. Make sure your activities are environmentally friendly.

- Do not litter or throw bottles and other rubbish overboard.
- Do use an environmentally friendly anti-fouling paint on your boat.
- Don't let oil and fuel spill into the water.
- Dispose of waste, thinners, paints etc. properly.

# The Environment

## **Plants and animals**

Wild animals and birds can be disturbed by human presence. Avoid hanging around close to birds' nests, particularly birds of prey

Keep dogs under control at all times and preferably on a lead as even their presence can frighten sheep, disturb wildlife and cause a nuisance to others.

Don't pick or uproot plants and mushrooms. If a record is required, take a photo.

Walk carefully so as to do as little damage to the vegetation and ground cover as is possible.

If you want to see wildlife try to keep quiet as many of our native animals are shy and elusive.

When camping all washing should be done well away from any water source. Any fouled water should not be returned to the water source, but poured into vegetation at least 100m from a water source. Soap isn't essential, but if you must use it, choose an eco-friendly type.

## **The Country Code**

Respect the rights of landowners  
Remember all entry to land is by permission of the owner, except where there is a right of way Avoid unwelcome entry on private property. Never camp without permission from the owner. All land in Ireland is owned by someone.

## **Keep to paths**

In farmland keep to the edge of fields to avoid ruining crops.

## **Close gates if you open them**

A gate left open allows stock to stray which might then damage crops, or get lost. It may also lead to road accidents. Do not damage fences, hedges or walls. Use stiles whenever possible.

Be careful with fire. Extinguish fires thoroughly.

## **Leave no litter**

Litter is dangerous, especially glass and tins which can injure and plastics which can choke wild animals, so take home all rubbish.

Even biodegradable items such as applebutts, banana skins and orange peel should be taken home.



# Kit-List

## Gear checklist

This is a list of gear needed for any weekend backpacking expedition. Tick off all the items as you do the final packing, keeping the final weight down as much as possible. Make sure all your gear is wrapped in poly-bags to ensure it's waterproof.

Personal gear- includes what you wear

- Hiking boots (waterproofed) & gaiters
- Thick hiking socks (4 pairs)
- Trousers or hiking breeches
- Thermal vest and long-johns (can also be used as pyjamas)
- Shirt (2)
- Jumper or fleece jacket
- Gloves or preferably mitts
- Waterproof over-mitts
- Neck scarf
- Fleece hat or balaclava
- Waterproof jacket with hood
- Waterproof over-trousers with wide opening zips
- Toothbrush, small tube of toothpaste, small towel, small piece of soap

- Lunch and flask
- Sleeping Bag and stuff sack
- Foam sleeping mat
- Pocket knife with tin opener, spoon, plastic plate and mug
- Polythene bag for rubbish
- Compass, navigation card and watch (ideally with a stop-watch function)
- Head torch (spare batteries / bulb)
- Plastic whistle attached to rucksack
- Emergency rations / GORP - good old raisins and peanuts
- Reflective strip attached to pack for road walking
- Large bivy bag
- Rucksack with optional side pockets
- Heavy duty plastic bag to line pack





# Personal Clothing

## The layered approach to clothing

Several thin layers of clothing that trap air between them will keep you much warmer than a single, thick garment.

If you get too hot, you can control your body temperature by removing layers or by 'venting' (opening zips or buttons) to allow warm air to escape and cool air to enter).

## The comfort layer

This first layer, which lies next to the skin, should consist of a thermal top and thermal leggings which should be close-fitting .

It should be made from a fabric that 'wicks' perspiration away from your skin and out through the next layer of clothing as perspiration drying on your skin can easily chill you. By keeping your body dry you will also keep it warm.



**The warmth or middle layer** allows you to regulate your body temperature by putting on or taking off garments as necessary. It could be a light fleece jacket worn over a shirt which allows for plenty of insulation by trapping air.

# Layered Approach

Hiking breeches or trousers must allow freedom of movement and should be made of a fabric that will dry quickly and retain its insulation properties when wet. Avoid wearing cotton which tends to cling when wet and takes a long time to dry. Wool and many of the newer synthetic fabrics retain their insulation properties even when wet.

**The outer or shell layer** in a three layered system provides protection from the elements. The jacket and leggings should be wind resistant and waterproof. Waterproof over-trousers should be worn in very wet and windy conditions.

Ensure that these have wide opening zips to allow them be put on and taken off easily over hiking boots.

## Tips

- In cold weather zips can be difficult to grip. A loop of cord attached through the zip can make it a lot easier to pull if you are wearing mitts.
- Don't wear jeans when hill walking. When wet they tend to cling, take longer to dry and can cause heat loss leading to hypothermia.

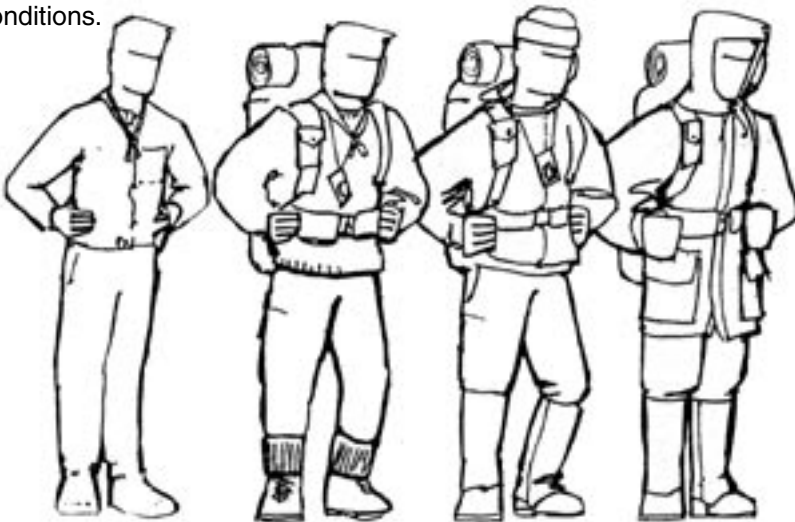

## TIPS

- **In the dark wear something bright and use your torch.**
- **Walk in single file facing the oncoming traffic**
- **Walk on the right. Wear something bright.**



# Backpacks

## Your pack

When choosing a pack concentrate on comfort and one that fits properly. Packs are measured in Litres. A 60 - 80 litre pack should be sufficient, especially with optional side pockets and an extendable lid. Most packs have compression straps to adapt them for varying size loads.

A loaded backpack must be well balanced with the weight bearing directly downwards and carried on your hips via the waist belt and not pulling your shoulders back making you hunch forwards. Additional stability is gained by adjusting the shoulder straps and chest harness.

Look for well padded shoulder straps, quick release buckles and heavy duty zips that will take the pressure of gear being stuffed into the pack. Most rucksacks have straps on the outside for tying on bulky items such as a sleeping mat or ice axe.



Nothing should be left dangling from the rucksack. During the day you will need to have access to waterproofs, camera, food and water without pulling out everything else, so think about where you place each item.

# Equipment

Ideally, heavy items should be packed high close to your back but avoid making the pack top heavy which could cause problems with your stability on steep ground.

A plastic whistle for use in emergencies can be tied onto the shoulder strap. The contents of your backpack should be made completely waterproof. A large heavy duty plastic bag or bin liner should be used inside your backpack to act as an effective membrane and even then it is advisable to pack smaller items again in individual polybags.

Side pockets are useful for small items, while a pack that can split into two compartments makes organising gear easier.

**A head torch** is the most convenient as it allows you to cook and pitch a tent in the dark while your hands are free. Don't forget spare batteries and bulb.

**A map case** hung around your neck can be a nuisance in windy weather. If you do most of your hiking in one area and constantly use the one map, it is a good idea to get it laminated. Laminated maps are a little bulkier but can be rolled up and stuffed down your gaiter where they are easy to get at.

**Bivvy bag** carried as an emergency shelter. They can be used to store your gear overnight if there is no room in the tent. In very wet conditions they can be placed under the tent's ground sheet. They come in various sizes, the larger one giving enough room to allow you get changed in, to store gear and in an emergency several people can get into the one bag to share body heat.

## Toilet requisites

Toothbrush, toothpaste (small tube) and a very small towel. If you need soap use a biodegradable type.

## Gaiters

These are useful in boggy wet conditions or when hiking through heather or snow. Shock cord is better than a boot lace to secure the gaiter under the boot as it stretches and does not need to be untied. Front zipping gaiters are easier to put on.

## Head protection

A fleece hat or better still a balaclava 'head over' which covers the head, the sides of the face and the neck, can prevent considerable heat loss. Many hillwalkers also wear a neck gaiter in winter.

# Equipment

**Outer mitts** The layering system also applies to your hand's with mittens being warmer than gloves and with waterproof mittens worn on top.

**Sleeping bags** A warm night's rest is essential for an enjoyable backpacking trip. Bag makers rate their bags by the season (e.g. 2 or 3 season) but these should only be used as a rough guide. How the filling is held in place, the type of filling and the amount will also determine warmth. Sewn through construction allows a lot of heat loss. Bags for all year round use are made with the inner and outer kept apart. Look for box or slant walls, overlapping tubes, shingle or double wall construction. The filling can be of either down or synthetic fibres.

Down is light, compresses well when packed and the weight for warmth ratio is good, but it is expensive and no good when wet. Some people are also allergic to down.

Synthetic fibres have better insulation properties when wet but are bulky and heavier. A compression stuff sack can help reduce bulk. A rough guide for a 3 season bag would be 1500g of filling for a down bag and 2000g for synthetic fibres.

Bag designs have differing features, some of which can effect warmth (e.g. tapered feet, hood and draw cord, half-full-length or no zip, two-way zips).

**Foam mat** Insulates you from the cold ground giving you a warmer and more comfortable night's sleep. There are different grades of foam mats giving various levels of insulation. There are also inflatable mats which are expensive but extremely comfortable and warm. Mats can be bought in various sizes to reduce weight e.g. full or three quarter length.

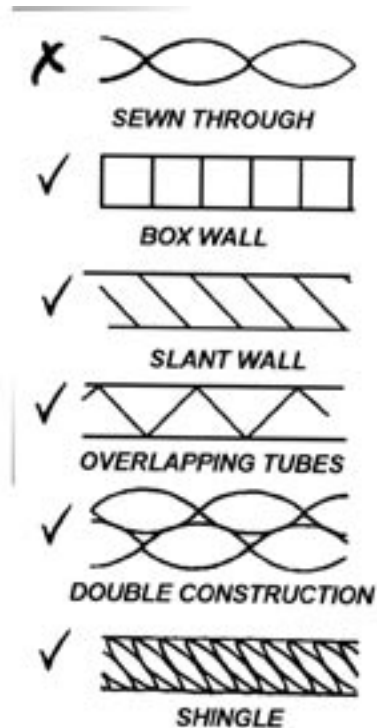

# Hiking Boots

Hiking boots - A key to enjoyable hiking is comfortable footwear. Canvas type boots, while fine in summer and in rocky terrain, are not much use in wet Irish moorland. In the wet boggy terrain that makes up so much of our mountains few boots will keep you dry but they can still be warm if two pairs of hiking socks are worn.

Two thick pairs of hiking socks reduce the friction between boot and foot which usually causes blisters. Bring several extra pairs so you have a dry pair to change into when you get to your camp site or at night.



## Foot care tips

When hill walking your feet do most of the work so it pays off to look after them. Here are a few tips to make your trip more enjoyable

- Before using new hiking boots break them in by wearing them around your house and in the street for a few days.
- You can cut down foot shock by using an insole.
- Inspect your feet occasionally and if there are signs of abrasion apply a plaster or put on another pair of socks.
- Use a foot-powder before getting into your sleeping bag at night.
- Blisters can be pierced with a sterile needle to let the fluid out (heat the needle with a match to sterilise). Do not remove the skin as it is a natural sterile dressing.
- Look for good ankle support and padded ankle cuff
- Look after your boots by cleaning and waxing them after every trip. Dry them out slowly by putting crumpled up newspaper in them. Do not dry boots by the fire as direct heat of this nature can cause the leather to crack.
- Buy boots a size bigger than your normal shoe size. Try them on in the shop with two pairs of socks.

# Group Equipment

**Group equipment will have to be shared out evenly between all the group members**

- Maps (minimum 2)
- Map case or laminated maps
- First Aid Kit & pencil, paper
- Poles and Hike tent (with some bulldog pegs and poles)
- Trangia stove, fuel in marked fuel container
- Matches in 35mm film canister
- Unbreakable flask
- Rations packed in lunch boxes
- Wash up cloth or pads
- Safety rope (30metres) of 7mm rope
- Small amount of toilet paper in a plastic bag.
- Collapsible water bag i.e. the inside of a wine box
- Midge repellent (summer only)
- Sun cream, lipsalve.

## Optional extras

- Playing cards
- Personal stereo / radio ( for weather forecasts)
- Paperback book
- Guidebook
- Camera and film
- Mobile phone
- Flare

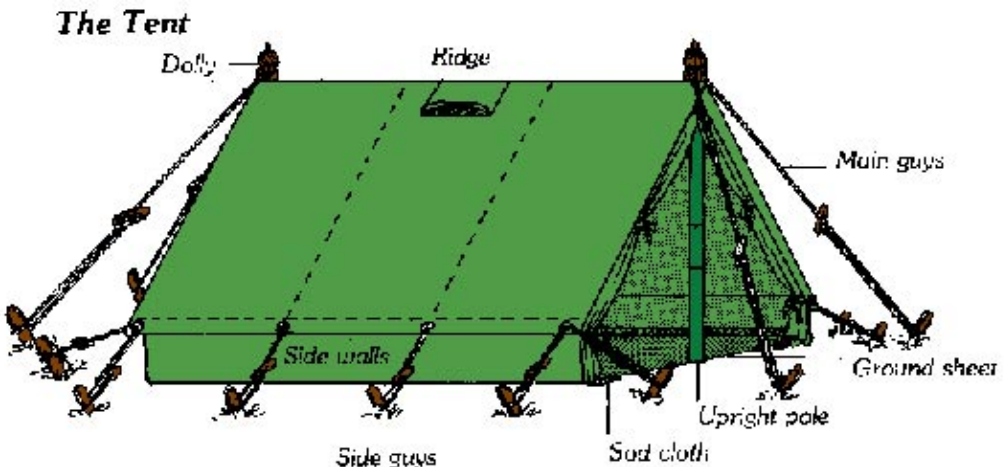

# Hike Tents

## Hike tents

There is such a variety in tent designs now that it would be difficult to go through the pros and cons of all of them here.

Here are the main features to look for in a two person tent.

- The inner should be roomy enough so that two people can sit up comfortably and can change in it if the weather is bad.
- A fly sheet with a porch extension provides space for cooking in bad weather and for storing gear at night.
- The fly should be tight so that it does not touch the inner and will not flap in the wind. It should peg down to the ground as low as possible to prevent the wind getting under it.
- Fitted ground sheets should come up a little at each side to prevent damp entering.
- When purchasing the tent keep the weight in mind and think what it will add to your pack even when split up between two or three. A two person tent should weigh about 3 - 4 kg.





# Lightweight Stoves

## Trangia stoves

The basic element in any backpacker's kitchen is the stove. The most popular stove for beginners is the Trangia which uses methylated spirits (Meths). It is easy to use and works well in windy weather. Another big plus is the simplicity and reliability of the Trangia meths stove, having no moving parts and requiring no priming.

About 1 litre of meths will do two people for a weekend if you are careful about what you cook. It's not a hot fuel, roughly twice as much being needed for the same heat output as other fuels so it's comparatively expensive to run and it can be slow in cold weather. The Trangia is available in several sizes and comes with two pots, a frying pan which acts as a lid and a built in wind shield. It is also available with gas fitting.



## Stove safety

All stoves are potentially dangerous and need to be handled carefully. Read the manufacturer's instructions. Never use in the tent. If it is raining cook from the tent or in the porch if the tent has one.

When you do this make sure there is adequate ventilation as all stoves give off poisonous carbon monoxide fumes. Also ensure that nothing flammable is near by as many light weight fabrics used in tents and other camping equipment melt easily.

## Refilling your stove

Refilling a stove should always be done outside, taking care not to spill fuel and that there are no naked flames nearby. Meths burns with an almost invisible flame so do make sure that the Trangia burner has definitely extinguished and has cooled down before refilling.

Afterwards, ensure that fuel bottle caps are screwed down tightly before you light the stove. Use a proper fuel bottle which has been clearly labelled.



# Backpackers Menu

Lightweight menu planning starts at home. Try a dish in advance; find out if you can cook it easily, how long it takes to prepare, amount of fuel used, cooked quantity and if you like the taste.

- Bring a small plastic bag for your rubbish.
- Leave surplus or unnecessary packaging at home. Cut out cooking instructions and repack food in lunch boxes.
- Mark commonly used volumes, measures, on the outside of food containers. How much does your mug hold, your cooking pot?
- Pack all items for one meal together; this saves searching through rucksacks to find the necessary items.
- Plan to avoid monotony - take along a selection of 'extras' to add to the meal, e.g. condiments, salt, herbs, soya sauce, an Oxo cube. Lightweight fresh food, such as peppers or mushrooms.

- 35mm film canisters can be used for oil, butter, soya sauce etc.
- Use the space inside the stove to store small items. Keep weight and bulk down, but eat well and drink lots.
- Avoid long cooking times which use up fuel.
- If possible add fresh and home-made foods, but keep the packs light.
- Snack food for eating on route is an important part of backpacker's menu.

## Food

On long trips the weight of your food can become a problem. That's when specialist dehydrated and freeze dried foods are a good idea. There is a large variety of these available from most supermarkets. Backpacking is hard work, so more calories than usual are needed. Therefore reckon on about twice your normal intake.

Foods that cook in a few minutes are best. That way you get a meal quickly and save on stove fuel. However, quick-cook meals aren't noted for their taste and it is nice to add some fresh ingredients

# Emergency Rations

## Menu suggestions

Breakfast - The most important meal of the day

Muesli, mix in powdered milk and sugar at home, add hot or cold water.

Frankfurter sausages are far easier to cook than the traditional fry.

Bread buttered beforehand, pre-cooked hard -boiled eggs, dried fruit. Tea , coffee, drinking chocolate or dehydrated orange powder.

## Lunch

Sandwiches (made at home), cheese, cold meat, peanut butter, paté, fruit-cake, biscuits, fruit, chocolate. A flask with a hot drink.

## Snacks

for eating on the move: nuts, fruit, chocolate, GORP (good old raisins and peanuts) & boiled sweets.

## Dinner

There is a huge variety of dehydrated meals available: quick-cook rice, pasta. Dried vegetables, “cup of soup”, crackers. Avoid tinned food as it is heavy. Some instant desserts can be made with water. Dried fruit.

## Emergency Rations

Biscuits, chocolate, nuts, GORP, dried fruit and dates, Mars bars, Gluco tabs, boiled glucose sweets etc.

Anything with a high sugar content and which will convert into energy quickly.

Food provides the energy for the things we do. Make sure that you eat and drink well when hill walking, especially when you are wet and tired when it's tempting to just crash out in your tent.



## TIPS

Backpackers can eat straight from the pot. The only cutlery needed is a spoon, a pocket knife and a plastic mug.

An empty plastic 35mm film canister makes a good waterproof container for matches and a small piece of emery paper.

GORP - (Good Old Raisins and Peanuts) is an easy to make emergency ration. A mix of nuts, raisins, seeds, chocolate chips, etc. It can also be eaten on the move as a snack food.

# Personal Gear

## What do we need to bring?

That depends on the type of camp. Nowadays, many people go on light-weight expeditions. Others just pick a spot and stay put in the one place “a standing” camp. The type of gear you bring obviously varies. Here is what you need for a standing camp.

## ACTIVITY GEAR

A complete change of clothing

Shorts

T-shirt

Warm sweater

Underwear

Hiking socks

Waterproof anorak

Hiking boots

Trainers

Woollen hat & gloves

Swimming togs

Raincoat and waterproof trousers

## EATING GEAR

A plastic plate & bowl

Knife, fork, spoon

Mug

Tea towel

## SLEEPING GEAR

Sleeping bag

Sheet bag

Ground sheet or bivvy bag

Pyjamas or warm sleeping gear

Foam mat

## CLEANING GEAR

Towel and soap (environmentally friendly)

Toothbrush and tooth paste

Personal first aid kit

Torch (spare bulb and batteries)

Pen and paper

Clasp knife

# Group Equipment

## GROUP EQUIPMENT

Cooking Gear

Pots - 2 or 3

Frying pan

Fish slice / bread knife/

ladle

Potato peeler

Tin opener

Water container

Kettle

Washing up gear

Tea towels

Brillo pads

Washing up liquid

Basin or bucket

Washing pads & brush

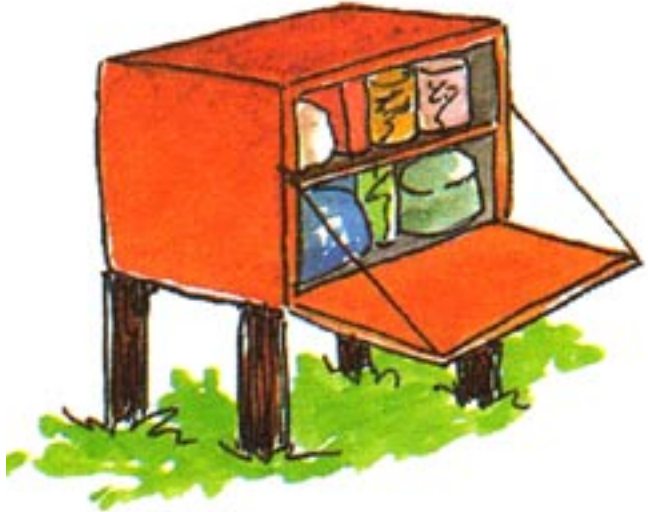

## Others

Axe and saw

Stove and fuel

Firelighters

Rope and twine

First aid kit

Refuse bags

Cool box

Small containers or plastic bags for sugar, lunch packs



## Tip

Use your watch box that you transported your gear in to make a store box in your camp kitchen.

Stack smaller pots into larger pots and fill smaller pots to make use of space.

# Choose a Campsite

## Choosing a campsite site

There are many recognised campsites throughout the country with some providing activities and qualified instructors. But many troops also camp in green field sites. Having decided where you want to go check the map of the area or if you know someone who has been there before, talk to them, they might know what there is to do in the area.

If using public transport, remember to check for distance from where you alight, to where you are camping. Organise your equipment so that it is easy to carry. Arrange for heavy equipment to be brought to the site.

## Check for the following:

- A safe water supply.
- Is the site well drained
- Do you need firewood?
- Are there shops nearby?
- Is the site sheltered from the wind?
- Have you got permission to use the land if it is farmland?
- Will you need to bring a toilet tent?
- Is there any danger nearby, cliffs or fast flowing rivers you should be aware of?

As the weather here is so changeable it is a good idea to visualise the site in the worst conditions. Take a little time and choose the best place. Avoid marsh ground which might become waterlogged. Ideally, look for a dry area that is slightly raised. Avoid areas with rocks and stones and clear pebbles before pitching your tent.



## TIPS

- *Don't dig drainage ditches around your tent. Look for a drier site.*
- *Build your fire down wind and well away from your tent.*
- *Is there any shelter from the prevailing wind?*
- *Avoid fields where there are cows or sheep dung pats to minimise the risk of infection with enteric bacteria causing food*

# Tents

Many tents blow down not because of the tent's design but because of bad pitching. First of all, the site you choose should give as much shelter as possible to the tent. Ideally, pitch in the lee of crags, trees, an earth bank or someone else's better tent! Avoid damp ground which is likely to flood and where vegetation damage will be greatest.

The direction of pitching should take account of wind direction, usually tents are best with their back to the wind. Finally, the tent should be pitched well; all pegs firm, at a 45 degree angle; fly sheet taut; storm guys well placed; good spacing between fly and inner.

Avoid camping near fast flowing rivers or crags that could be a danger at night should you need to take a leak. All washing should be done away from the water source and fouled water poured into vegetation 100 metres from it.

The area chosen as a latrine should be at least 100 metres from any water source. Bury your toilet waste. Burn your toilet paper if it is safe to do so, otherwise bury it also.

## Improving your tent

Most basic hike tents can easily be upgraded to storm-proof them for Irish weather.

- Replace some pegs. The 'meat skewer' type sold with many light weight tents are only suitable for pegging down the inner. The angled 'bulldog' type are best for pegging down the fly sheet and storm guys. Bring extra ones for double pegging points on soft ground.
- Bring extra line for storm guys and peg them as far out as possible.
- Sew on extra guying points around the base of the fly sheet.
- Replace weak 'rubber bands' at guying points with 'shock-cord' tied in loops.
- A silicone sealant can be used to waterproof stitched seams
- A bivvy bag placed under the ground sheet can prevent damage and damp ingress.

# Pitching Your Tent

## Pitching Your Tent

For standing camps a patrol tent such as an “Icelandic” is the most suitable as this can sleep 6-8 people. To pitch a heavyweight canvas tent - Lay the tent on the ground, assemble the poles, put them in place and then stand the tent upright. Close the doors on the tent, so as to ensure pegging down properly. Peg in the main storm guys and then the other guys so they are in line with the seams of the tent. Peg down the tent walls making sure there are no gaps. Put pegs in at a 45 degree angle as this will be the most secure.

It is a good idea to fold the groundsheet into the centre of the tent each day to air the ground underneath. Brail the sides of the tent if the weather is fine.

This way the grass will not die, if you are camping in the same spot for a some time.

## Tent care tips

- Make sure the tent is dry before it goes into storage. You can do this by hanging it up or draping it over several chairs. If you don't do this mildew will rot the fabric making it less wind and waterproof and reducing its life span considerably.
- Also make sure to do any running repairs that need to be done, stitch worn seams and replace lost pegs.
- Why not paint the top of the pegs a bright colour so that they are easier to see in long grass.

©





# Setting Up Camp

## Setting up camp

When setting up your camp site you will have to decide exactly where to pitch your tent and what other areas you are going to need for the duration of your stay.



## Included in the site plan should be.

- Sleeping area
- Cooking area
- Fire and wood area
- Dining area
- Fun / football area

Organise a proper food store and make sure everyone knows where the first aid kit is kept. Check out the campsite and know where to bring your rubbish. Work out a rota for the tasks that need to be done, e.g. washing up, cooking etc. This way everyone does their fair share. As soon as the tents are pitched, start collecting drinking water and wood for the fire.

The fire should be downwind of the tents and at least 4m away to avoid any chance of sparks damaging the fabric. Mark out your dining and cooking areas, making sure that fires or stoves are stable.

Ideally, cordon off the area so that only the cook is near the fire. Cordon off a space as a chopping area.



## TIP

*Each time a tent comes back, it should be dried by hanging it up to air, otherwise mildew will rot the fabric.*

*Repair any damage, particularly the guying points, and reinforce if necessary.*

# Altar Fires

## Altar fires

Nowadays, on many camp sites you are not allowed to light a fire on the ground or to lift a sod. A half metal barrel could be used as a base for your camp fire. Alternately, you could build a wooden base and place on this a metal sheet.

Make sure the altar fire construction is stable and unlikely to wobble i.e. notch the logs.

A layer of mud (in the case of a timber structure) should be put on top of the iron sheet to provide insulation so that the wood supports do not burn.

Cordon off the cooking area around the altar fire and ensure that only those doing the cooking are around the fire.

Use bricks or stones and a fire grate as these will help keep the fire small and keep the pots stable.



# Lighting a Fire

Use a fire lighter to start the fire if you don't want to waste time

Firstly, collect enough firewood. Green (fresh) wood is no good nor is damp wood that has lain on the ground too long.

To make your fire, get kindling; shavings, splinters, or any other material that will catch fire easily.



Above this kindling, place twigs in pyramid fashion. Then add a few slightly thicker sticks to make the fire. Have a wood pile ready before you light your fire.

## TIP

A good kind of kindling can easily be made by splitting a stick into several slices or shavings as shown. This is called a fuzz stick. If stood up, with the shavings pointing to the ground, it quickly catches fire and flares up

Make a graded wood pile of twigs, sticks and logs, before lighting your fire.

## FIRE SAFETY

Practice a fire drill. Know what to do . . . "Stop, drop, roll" if someone is on fire.  
Have a bucket of water handy.

# Fires

## Fires

Cooking is best done on a stove. If you still want a camp fire do so with as little environmental impact as possible.

- Take special care not to let fires get out of control especially during dry periods. It can take between 10 and 20 years for burnt moorland to recover and more than 30 years for the full establishment of the original level of growth. It is an offence to light fires within forest areas.

- Don't cut live wood.
- Select a safe non-scarring site such as a dry stream bed or flat rock.
- Completely extinguish a fire before leaving the site.
- Tidy up by dismantling the stone circle and replacing the rocks where you found them.
- Try to leave the site better than you





# Axe & Saw

## Axe and saw

Every time you go to use an axe, check that the head is secure and that the wedge is in tight. Check that there are no cracks in the haft and that the bit is sharp. Although it may seem odd, a blunt axe is more dangerous than a sharp one. The reason is that if you strike a log with a sharp axe, the axe will cut into the wood, if the axe is blunt it may glance off and hit you or somebody else.

Before chopping, check that there are no nearby obstructions, especially overhead, such as branches and that everyone else is at least two axe lengths away from you, and neither directly in front or behind you, should the axe slip.

### Tip

It is much easier to chop on a chopping block as this way there is no give in the piece of wood being chopped, making each blow more effective. Keep your fingers well out of the way of the axe when splitting wood and wear hiking boots.

## Bush saws

The bush saw is often far quicker than the axe and doesn't leave a pile of wood chips to be cleared up. Before using the saw, check that the blade is sharp and that it is taut (tight) in the frame. If the blade is blunt then put in a new one. (You'd be amazed at the difference it makes).

When using a bush saw, start off slowly until the cutting edge has a firm grip in the log and then off you go. The bush saw like an axe will become blunt if it digs into the ground, therefore it is always better to use a trestle or chopping block when sawing logs



# Clasp Knife

Many aspects of Sea Scouting involve working with ropes every Sea Scout should have a good clasp knife as part of their uniform and for use on activities. It should be attached to a lanyard and clipped onto your belt when in uniform or into your pocket when on boating activities or on camp.

Ideally the knife should be of stainless steel (as it will be in contact with salt water) and needs no more attachments other than a Marlin spike (for undoing knots) or possibly a shackle opener. A Knife with lots of attachments (most of them useless) is not the best option for sea scouting.

You should keep you knife sharp so that it will cut things easily A blunt knife is more dangerous than a sharp one because you have to hack at something to cut through and it is more likely to slip.

Sharpen your knife regularly by working it at an angle of about 30 degrees on an oilstone. You should lightly oil the moving parts of knife occasionally being careful to wipe off the excess oil.

Scouts are NOT allowed to carry sheath knives or other retractable knives.

## Safety tips

- A blunt knife is more dangerous than a sharp one.
- Never use a knife for playing games
- Always cut away from your hand
- Never run with an open knife.

**Don't forget to bring your knife!**

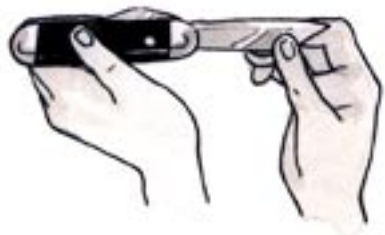

# Cooking

## Outdoor kitchen

Keep it simple. Preparing fussy food isn't easy in a well-equipped kitchen, let alone at a campsite.

Keep it clean - Wash your hands before handling food, clean and put away your pots, pans and crockery and have a clean food preparation area. 'Cut down on the pots and pans'. As well as being tasty, one-pot meals such as stews will leave your assistants with less washing-up to grumble about!

## Storing Food

Storing food is an important health aspect of camping. E.coli 0157 is a potential health hazard for all people camping on land that may have had livestock on it.

To kill E.coli 0157 all meat must be cooked thoroughly. Mince meat and burgers should be cooked until all the pink has gone from the interior and the juices run clear. Refrigerate meat and consume on the day of purchase. Prevent cross contamination by ensuring that raw meat or its juices do not come in contact with other food stuffs.

Wash all fruit and vegetables before eating. Wash your hands with warm soapy water after using the toilet and before handling food.

Food like cheese and milk can be stored in a cool box. Use the box in which you transported the pot and pans to camp as a storage box for thing like jam, sugar, coffee, bread, cereals.

## TIPS

Put your pots and pans away clean after each meal. While you are eating have a pot of water on the fire heating up to do the dishes afterwards.





# Menus & Camp Costs

## Menu Planning

There's nothing like fresh air for working up an appetite, so make sure you plan a good-sized breakfast and evening meal each day. It's best to take a picnic lunch if you're spending the day away from camp, with chocolate to eat as energy snacks mid-morning and afternoon.

### Keep in mind to:

Try to suit all tastes and special dietary needs, e.g.. diabetics, religion etc.

Use a variety of cooking styles, e.g.. frying, boiling, barbecue.

Think of the time involved.

Will fresh food like bread or milk be available locally?

What about snacks etc.? Apples, biscuits, Mars bars.

## Buying the Food

Once you have a rough idea of what you want to eat, break each meal into exact items and quantities.

### *Take breakfast as an example.....*

Eggs & rashers x 6

cereal, milk and sugar

bread, butter, jam

### *Or Dinner*

1 Packet Spagetti

1 1/2lb of mince

Onions

1 Tin Tomatoes

Oxo cubes

With each meal itemised like this it is easy to work out the exact quantities to buy at home and what you will need to get on site.

## Estimating the Cost

It is easy to estimate the cost of the camp weekend once you have decided where you are going, how you are travelling, what activities you will take part in, what food needs to be bought for the menu and how many are going.

### Use the following list to estimate the cost:-

Food

Transport

Purchase of special gear

Expendable purchases,

eg., fuel, twine, toilet rolls

Campsite fees

Activity fees

Equipment rental

First aid material

Emergency money

Total cost €

Number going on camp

Cost to each €

# Backwoods Cooking

## Foil cooking

This is best if each person cooks their own portion. Chop your food into small pieces and with some fat or cooking oil wrap it in a double layer of foil making sure it is well sealed and allow to cook for 20 minutes turning several times. Try rashers, onions, sliced potatoes and diced carrots.



## Backwoods cooking

Here you've got to make everything yourself. Get some green sticks. Take off the bark and heat them over the fire before using. You can then use them to grill the food.

Here are several ways to cook food without utensils. Sausages, toast and "twists" can easily be cooked on a stick.

Kebabs on a spit can include cubed meat such as chicken, pork, sausages along with tomatoes, onions, mushrooms and peppers.

**Twists:** Mix a small amount of flour and water in a plastic bag. Add raisins if you like. Roll out into a long "sausage" and wrap around a green stick. Cook slowly and when ready just pull off and fill with jam.

Marshmallows roasted on a stick make a delicious dessert.



## Tips

When cooking meat on a spit or skewer, remember that the fat dripping into the fire will create flames and could cause your food to burn. Getting the fire right is all important. For the best results, cook your food over a bed of hot embers. First, build up the fire and then let it burn down several times until it's a thick bed of glowing embers. If there is too much flame, you'd better like your food black and crispy!!!



# Bivouacs

## Bivouacs

Sleeping out can be a fun activity. Nights can be cool even when the days are very hot, so make sure you have a good sleeping bag and use an area that has some natural shelter such as an earth bank, stone wall or hedge.



## Tip

In the summer months midges can be a real nuisance so select a windy spot such as a beach or hill top and bring repellent. One way of making a bivouac is to hang a ground sheet over a length of rope tied between two trees, as shown. Heavy stones keep the bottom edges of the bivouac in place. An even simpler version uses a wall for support.



If you have a bivvy bag you can sleep on top of this and get into it at the first sign of rain. Place your boots upside down and pack all your gear into a plastic bin liner in your back pack. Bivvy bags come in various sizes, the larger one allowing you to store gear and even to dress in if it's raining.



This is fine for calm weather, but it should not be used in windy conditions as a strong gust could drag the stones on the wall down on top of you. Don't make bivvies out of natural materials, ie. sticks and fern as this is no longer environmentally sound

# Eco-Camping

## Eco-camping

All washing should be done away from the water source and fouled water should not be returned to the water source but strained through loose grass in your wet "pit" which can then be burnt. Grease from cooking can be disposed of in the same way.

Put your other rubbish in a strong plastic bag, ready to be emptied into a site bin or taken with you when you leave.

Be sure to bag up all tins and bottles and bring them home for recycling.

Burn paper packaging and cartons on your camp fire.

Don't cut live wood. Keep fires small to conserve wood.

Plan to minimise rubbish. Buy items with little or no packaging, remove excess packaging at home, cutting out the cooking instructions.



**LEAVE THE SITE BETTER  
THAN YOU FOUND IT**

# Striking Camp

## Striking Camp

When it's time to go home you have to dismantle your camp site, pack the gear and clean up the site. This is known as 'striking camp'. It is best to follow a routine, packing your gear first and taking down the tent last.

After your last meal, wash up and prepare food, if needed, for the journey home. If you used a stove, leave it to cool, then empty and clean it. Take down the tent by removing the pegs, cleaning off mud or soil, putting them in a peg bag along with any loose guys. Fold the tent, making sure there is no debris on it. If it has a loose groundsheet make sure it is dry, before you pack both away in the tent bag. Bring all your rubbish to the recycling bins.

Do a sweep of the campsite and take unused firewood and spars from dismantled gadgets back to the correct storage areas. Leave the site exactly as you found it or better. On arriving home check over all the equipment before it is stored. Air the tent to make sure it is dry or mildew will rot the fabric.

Check the tent for any tears and repair them. Air your sleeping bag. Clean your hiking boots. Brush or scrape mud off, then leave to dry before waxing them.



## Tips

- Never dry your hiking boots by the fire as it can cause the leather to crack. Dry them out slowly by stuffing them with newspapers.
- If your tent is damp when you return from camp, it should be thoroughly dried before being packed away. This can be done by draping it over some chairs in your den or a garage etc.



# Fitness

## What is fitness ?

Long ago human beings' survival depended on their physical fitness, their strength and stamina to hunt and trap and explore, their ability to fight, and if necessary escape. Primitive people spent most of their time in physical activity, so they automatically had a high level of fitness.

Too many people spend their lives sitting down, and the number of people depending on physical work for a living is becoming smaller every day. While machines do the work, modern people pay the penalty for soft living several ways: they develop flabby muscles, are overweight, and have tension and heard disorders. To survive we have to make up for our lack of physical work by using our leisure time in a more active way, participating in exercises , games and sport.

Our physical strength and stamina allows is to function close to our peak for a particular age. We can work or study efficiently, participate in games and sport, enjoy our leisure, and nevertheless have enough reserves for an emergency.

Your fitness depends entirely on you: it is a personal matter,. You yourself need to learn a variety of physical skills and activities and to participate in them regularly.

Health is closely related to physical fitness, but keep in mind that the presence of certain diseased does not necessarily preclude fitness. Many famous sports people have diabetics, suffer from asthma, or been survivors of polio. Their sporting achievements show that not all diseases are barriers to physical fitness.

Good habits include eating proper food, personal hygiene, having regular exercise and having adequate sleep. Regular check-ups by your doctor and twice yearly visits to the dentist re important.

..... large quantities of sweets, biscuits, potato chips and soft drinks: these supply useless calories and cause tooth decay. Keep in mind that what you eat must provide fuel for energy and growth





# Your Health

Four main groups of food containing proteins, fats, carbohydrates, vitamins and minerals are necessary for good health. A satisfactory diet contains a variety of foods from the following categories: -

Milk in any form, at; least 500 millilitres per day. Cheeses, powdered milk or unsweetened evaporated milk. Milk and cheese provide protein and vitamins and are the best source of calcium.

Meat, fish poultry and eggs: dried beans and peas, lentils and peanuts. These foods provide protein and also contain vitamins and minerals.

Bread, flour and other cereals. Whole-meal varieties are better food value. These foods supply carbohydrates, several B vitamins and minerals.

Vegetables and fruit: Leafy green, orange, or yellow vegetables for vitamin A, Fruit or vegetables rich in vitamin C, and two other servings of vegetables or of fruit, including potato, This group provides vitamins and minerals.

Butter or table margarine: These are sources of vitamin A and calories.

Without adequate sleep, you will never be truly fit., and your growth and health may suffer. While you are growing, the body uses a lot of energy and getting enough sleep is an absolute necessity, you will need nine to ten hours every night.

The skin has to be kept clean, and any cuts or abrasions treated carefully to prevent infection occurring. Wounds can harbour tetanus germs essary. Bowel, upsets are usually due to dirty hands contaminating food. Some people can be "carriers" and transmit diseases to other although they do not suffer from it themselves: this happens with typhoid fever.



# Your Body

## Components of Fitness

Every exercise programme should aim to improve all aspects of physical fitness. The components that make up the hard core of fitness can be classified as follows: -

- Endurance or stamina
- Strength
- Mobility

Endurance is the ability to keep on performing movements such as running, swimming, cycling and walking, for a long time. Endurance, often also called stamina, depends on how well your heart and lungs can deliver oxygen to the working muscles

When you run, your heart speeds up, blood flows quickly, and lungs work hard. If you are fit and have good stamina, you can keep on for a long time. However, if your endurance is low, you will be gasping for breath soon after you start to exercise.

Strength is the muscles' capacity to exert force when they contract. Strength is determined among other factors by the size of the muscles if you are very strong; the thousands of movements that occur every day become a lot easier and more efficient.

Another important factor of fitness is mobility. It depends on flexibility, suppleness, balance and the agility to change direction quickly.

Suppleness and flexibility decide the extent of movement in the joints. An agile and supple person can perform a wide strain on muscles and ligaments.

## Training

Before you begin your keep fit campaign, remember the following golden rules: -

1. Train don't strain. If you find your training leaves you exhausted the next morning, check your programme. Do not be lazy but do not try to become fit in a day or two.

2. Be dedicated. You will have to keep at it. Peak physical fitness may take a long time to reach, but once you stop training, your fitness level will drop very rapidly.

3. Start gradually. Be patient. Work hard and regularly but do not start by working until you drop exhausted. At the outset, take it easy and allow your body to adapt to the new demands.

4. Be progressive. After you have reached basic fitness, set yourself progressively harder tasks with the help of a professional fitness trainer / adviser. You can improve your fitness only by steadily increasing the amount of training.

Be regular. Haphazard training has no value and it is always better to work a little every day rather than have a long session once or twice a week.

# Nautical or Sea Terms

Every Sea Scout must be familiar with the language of the sea, which may sometimes seem a little quaint to land-lubbers, but which has grown up through the long years.

## The Parts of a Ship

<b>Abaft</b>	Behind
<b>Admidship:</b>	Where the fore and the after part meets.
<b>After part:</b>	The rear left of the ship.
<b>Aft:</b>	From any point in the ship towards the stern.
<b>Athwartship:</b>	Across the ship from side to side.
<b>Abeam:</b>	Directly at right angles to the fore and aft line.
<b>Abreast:</b>	Level with, in line with.
<b>Ahead:</b>	Directly in advance.
<b>Alongside:</b>	Side by side, and touching.
<b>Astern:</b>	Directly in rear.
<b>Aloft:</b>	Up a mast
<b>Beam:</b>	The width of a ship
<b>Bulkheads:</b>	Walls in a ship.
<b>Belay</b>	To tie or Make fast
<b>Below:</b>	Inside the ship between the decks.
<b>Bottom:</b>	The sides around the hull below the water line.
<b>Bows:</b>	The hull surfaces in the fore part, which are rounded to meet the stem (Starboard and Port).
<b>Bridge</b>	Where the ships is controlled from
<b>Derrek</b>	
<b>Deadlights:</b>	Port hole doors for darkening a ship and keeping it watertight.
<b>Deck:</b>	Underfoot (floors).
<b>Deck Head:</b>	Overhead (ceiling)
<b>Decks:</b>	Horizontal surfaces of ships.
<b>Draught:</b>	The amount of the boat under the water.
<b>Fathom</b>	Six feet in length
<b>Fore &amp; Aft</b>	A sail hoisted along the length of a boat
<b>Midship line:</b>	The line dividing the ship from stem to stem.
<b>Fore Part:</b>	The front half of the ship.
<b>Forecastle:</b>	The fore end of the upper deck between the bows. (foc'sle)
<b>Forward:</b>	From any point in the ship towards the bows. ( <i>For'ad</i> )
<b>Freeboard:</b>	The height of a ship's deck above the water line.
<b>Galley</b>	Ships Kitchen
<b>Hatch:</b>	A square opening in the deck.

# Nautical or Sea Terms

<b>Hull:</b>	The main body of the ship.
<b>In:</b>	A seafarer serves “in” a ship.
<b>Ladder:</b>	That which gives access to the decks above.
<b>Leeward</b>	Away from the wind
<b>Let go:</b>	Untie or free a rope
<b>On Board:</b>	When a seafarer joins a ship.
<b>Port Side:</b>	The left hand side of the ship when facing forward.
<b>Ports:</b>	Ship’s windows.
<b>Quarterdeck:</b>	The after part of the upper deck.
<b>Starboard Side:</b>	The right hand side of the ship when facing forward.
<b>Stem:</b>	The extreme end of the fore part.
<b>Stern:</b>	The extreme end of the after part.
<b><u>Surfaces</u></b>	
<b>Ship’s Side:</b>	The sides around the hull above the water line.
<b>Superstructure:</b>	Any part of the hull, which is built above the upper deck. The decks below are called the main deck, middle deck, lower deck, platform deck etc. according to the side of the ship.
<b>Under way:</b>	Proceeding through the water
<b>Upper Deck:</b>	A deck exposed to the weather.
<b>Watch</b>	Period of Duty
<b>Windward</b>	Towards the wind
<b>Waist:</b>	The remaining deck between the quarterdeck and the fore castle.

## **Describing Position**

### **General Terms**

#### **Position of Outside Objects Relative to the Ship**

#### **Movement of objects on Board**

A seafarer speaks of going “forward”, “below”, “on deck” and “afloat”, i.e. anywhere in the rigging of a mast. They use the same expressions for shifting an object, always reckoning in terms of the ship: thus they may shift an object “aft”, or “further forward”, or “inboard” or “nearer the ship’s side.

# Nautical or Sea Terms

<b>Freeboard:</b>	The height of a ship's deck above the water line.
<b>Galley</b>	Ships Kitchen
<b>Hatch:</b>	A square opening in the deck.
<b>Hull:</b>	The main body of the ship.
<b>In:</b>	A seafarer serves "in" a ship.
<b>Ladder:</b>	That which gives access to the decks above.
<b>Leeward</b>	Away from the wind
<b>Let go</b>	Untie or free a rope
<b>On Board:</b>	When a seafarer joins a ship.
<b>Port Side:</b>	The left had side of the ship when facing forward.
<b>Ports:</b>	Ship's windows.
<b>Quarterdeck:</b>	The after part of the upper deck.
<b>Starboard Side:</b>	The right hand side of the ship when facing forward.
<b>Stem:</b>	The extreme end of the fore part.
<b>Stern:</b>	The extreme end of the after part.
<b>Ship's Side:</b>	The sides around the hull above the water line.
<b>Superstructure:</b>	Any part of the hull, which is built above the upper deck. The decks below are called the main deck, middle deck, lower deck, platform deck etc. according to the side of the ship.
<b>Under way</b>	Proceeding through the water
<b>Upper Deck:</b>	A deck exposed to the weather.
<b>Watch</b>	Period of Duty
<b>Windward</b>	Towards the wind
<b>Waist:</b>	The remaining deck between the quarterdeck and the forecastle.

## **Describing Position**

## **General Terms**

### **Position of Outside Objects Relative to the Ship**

### **Movement of objects on Board**

A seafarer speaks of going "forward", "below", "on deck" and "afloat", i.e. anywhere in the rigging of a mast. They use the same expressions for shifting an object, always reckoning in terms of the ship: thus they may shift an object "aft", ore "further forward",

## Membership Badge

### **1. SCOUTING**

- (a) The Scout Promise and Law
- (b) History of Scouts
- (c) Troop, Watch, WL & SSL
- (d) Sign, Salute, Handshake and Motto
- (e) Drill Movements
- (f) The Sea Scout uniform

### **2. ACTIVITY**

- (a) Outdoor activity
- (b) Gear for activities

### **3. NAVIGATION**

- (a) Find "North" using a compass
- (b) Symbols on a map
- (c) Grid reference

### **4. ROPE WORK**

- (a) Reef knot and Sheet Bend
- Round turn and 2 1/2 hitches
- Clove Hitch and Figure of Eight

### **5. WATER SAFETY**

- (a) Safety of Swimming
- (b) Importance of Swimming
- (c) Swimming Ability
- (d) Buddy system
- (e) Put on a life jacket or buoyancy aid
- (f) Care of a life jacket or buoyancy aid
- (g) Boating Safety

## Sea Scout Badge

### **6. SCOUTING**

- (a) Progressive training scheme
- (b) The Attainment badges
- (c) Watch activity and / or Watch meeting
- (d) The Scout Promise and Law

### **Initialled**

### **7. FIRST AID**

- (a) Personal First Aid kit
- (b) Small cuts and scratches
- Nose bleeds, stings and bites
- (c) The Recovery Position
- (d) Hypothermia
- (e) Sunburn
- (f) Asthma

### **8. NAVIGATION**

- (a) Features and symbols on a map
- (b) Parts of a compass
- (c) True, Magnetic and Grid North
- (d) Find Magnetic and True North
- Set a map
- Grid and a Magnetic Bearing
- (e) Contour lines
- (f) Compass activity

### **9. HIKING**

- (a) Personal gear for a day hike
- (b) The Country Code
- Safety of road walking and Hiking
- (c) Emergency rations kit
- (d) Take part in a Day hike

### **10. ROPEWORK**

- (a) Membership badge knots
- Fisherman's bend
- (b) Coil a rope and heave a line
- (c) Square and Figure of Eight lashing

### 11. **CAMPING**

- (a) Personal gear for a weekend camp
- (b) Pitch and strike a tent
- (c) Care for and ventilate a tent 
  - Keeping dry in a tent
  - Fire drill
- (d) Cook a meal on an altar fire
- (e) Personal hygiene on camp
- (f) Striking camp
- (g) Go on camps

### 12. **ENVIROMENTAL AND COMMUNITY**

- (a) Environmental or community project

### 13. **MAINTENANCE**

- (a) Maintenance or repair of equipment
- (b) The Scout Promise and Law

### 14. **WATER SAFETY**

- (a) Safety of Swimming and Water activities
- (b) Lifejacket and buoyancy aid
- (c) Choosing Lifejacket or Buoyancy aid
- (d) The gear to wear for a water activity 
  - Safety relating to the particular craft
  - Falling out of a craft
- (e) Be able to get into a craft from the water
- (f) Weather forecasts

### 15. **WATER ACTIVITIES**

- (a) Wear the gear for the Water activity
- (b) Know the parts of the craft
- (c) Rig and de-rig of the craft
- (d) Get in and out of the craft
- (e) Go on water activities

### 16. **ACTIVITIES AFLOAT**

#### (i) **RAFTING**

- (a) Make a raft
- (a) Paddle the raft forward and stop 
  - Paddle the raft around a course
  - Come along side without bumping
  - Anchor your raft
  - Pick up a mooring line or marker buoy

#### (ii) **OARS, SAIL or POWER (Single / Crew)**

- (a) Commands and terms used in boating
- (b) Move the boat around a course and stop 
  - Turn tightly
  - Come along side without bumping
  - Anchor your boat
  - Pick up a mooring line or marker buoy
- (c) Crewing a larger boat (Sailing)
- (d) Start and stop an engine (Power)

#### (iii) **CANOE/KAYAK**

- (a) Commands and terms used in canoeing
- (b) Paddle the canoe forward and stop 
  - Paddle the canoe around a course 
    - Turn the canoe in both directions
  - Pick up a mooring line or marker

## **Boatman Badge**

### **17. SCOUTING**

- (a) The Scout Promise and Law
- (b) Watch meeting/activities
- (c) The Watch system and the W.L.C.

### **18. WEATHER**

- (a) Weather forecasts for activities
- (b) Weather on the waters in your area
- (c) The Beaufort wind and sea scales

### **19. FIRST AID**

- (a) Improve your Personal First Aid kit
- (b) Minor burns, fainting and sprains  
Blister, shock and choking
- (c) Artificial resuscitation
- (d) Hypothermia

### **20. NAVIGATION**

#### **(i) Land Navigation**

- (a) Route card for a hike
- (b) Finding "North" without a compass
- (c) Navigate in poor visibility
- (d) Pinpoint your position using the features

#### **(ii) Coastal Navigation**

- (a) Longitude and Latitude on a chart
- (b) Features and symbols on a chart
- (c) Scales on a chart
- (d) Plot a true bearing using a compass rose

- (a) Steering and Sailing Rules
- (b) Steering and Sailing Rules terms
- (c) Terms used to denote direction

#### **(iii) Inland Waterway Navigation**

- (a) Scale of a O.S. Map and distance
- (b) The National Grid system and position
- (c) Symbols and scales on an Inland chart
- (d) Cardinal and Half Cardinal points
- (e) Manoeuvring rules on Inland Waterways
- (f) Locks

### **21. HIKING**

- (a) Prepare for a weekend hike camp
- (b) Store of food on a hike
- (c) Improve your Emergency rations kit
- (d) Safety of portable lightweight cookers
- (e) Prepare and cook a meal
- (f) Use a map to pick the easiest route
- (g) Hike, take bearings and back bearings

### **22. ROPEWORK**

- (a) Bowline, sheer and diagonal lashings
- (b) Stop a rope from fraying

### **23. CAMPING**

- (a) A balanced menu for a weekend camp
- Plan, cost and shop for the food
- Plan the division of the work
- Pack the camping equipment
- (b) Camp layout
- Camp food storage
- (c) A hand axe, bush saw and a clasp knife
- (d) Graded woodpile
- (e) Make camp gadgets
- (f) Cook a two-course meal on an open fire
- (g) Go camping



**24. ENVIRONMENTAL AND COMMUNITY**

- (a) Voluntary project
- (b) Visit your local rescue service
- (c) How to support the rescue services

**25. MAINTENANCE**

- (a) Help regularly with maintenance
- (b) Lead in maintenance projects

**25. WATER SAFETY**

- (a) Care and use of a lifejacket/  
buoyancy aid
- (b) Checking a lifejacket or buoyancy aid
- (c) Distress signals for a small boat
- (d) Types of anchors
- (e) Anchoring
- (f) Parts of an anchor
- (g) Sea anchor

**27. WATER ACTIVITIES**

- (a) Personal clothing and safety  
equipment
- (b) Equipment to be carried in a small  
craft
- (c) Safety points of the boat or canoe
- (d) Care of the craft and all its equipment
- (e) Launch and retrieve a boat or canoe
- (f) Show others how to rig and de-rig
- (g) Go on water activities

**28. ACTIVITIES AFLOAT**

- OARS – “O” (Crew), SAIL – “S”  
(Crew or Dinghy) or POWER BOAT – “P”
- (a) Forward and reverse (O & P)
  - Turn using the tiller or oars (O & P)
  - Sail a triangular course (S)
  - Steer the boat at varying speeds(P)
  - Emergency stop
  - Coming along side

- (b) Anchor your boat
- (c) Simulated rescue
- (d) Pick up a marker from the water

**(i) CANOE/KAYAK**

- (a) Slap support on both sides
- (b) Draw stroke on both sides
- (c) Turn in both directions
- (d) Raft-up
- (e) Capsize wearing a spray-deck
- (f) Swim towing the canoe and paddle
- (g) “H” or assisted “X” rescue

**29. FLAGS AND TRADITIONS**

- (a) Ensign
- (b) Fly a National Flag or Ensign
- (c) Carry a National Flag or Ensign
- (d) Care for National Flag or Ensign
- (e) Nautical flagpole and flags on a  
vessel
- (f) Maritime Tradition or history

**Coxwain Badge**

**Note: In the Coxwain Badge, there are two sections, one compulsory and the other has choices,**

**SECTION 1 - COMPULSORY, COMPLETE ALL THE FOLLOWING TOPICS**

**30. SCOUTING**

- (a) Teach the Scout Promise and Law
- (b) Display Scouting
- (c) Watch activities
- (d) Explain the challenges available

### 31. WEATHER

- (a) How clouds are formed
- (b) Types clouds
- (c) Rain, Fog, Wind, Sea and Land Breezes
- (d) Teach on how to get a weather forecast
- (e) Natural weather signs

### 32. FIRST AID

- (a) Emergency incidents
- (b) Asthma attack
- (c) Method of diagnosis
- (d) Teach how to resuscitate
- (e) Alternative method of resuscitation
- (f) Circulation system
- (g) Chest compressions

### 33. NAVIGATION

#### (i) Land Navigation

- (a) Detailed route card
- (b) Teach how to navigate
- (c) Contour lines
- (d) A Concave and a Convex slope
- (e) Improvised compass

#### (ii) Coastal Navigation

- (a) The types of compass and how it works
- (b) Magnetic Deviation
- (c) Bearing using Variation and Deviation
- (d) Nautical mile, Knot and Charted Depth
- (e) Light characteristics of navigation marks
- (f) The IALA Buoyage System

### (iii) Inland Water Navigation

- (a) The types of compass and how it works
- (b) Magnetic Deviation
- (c) Navigation system used on Inshore
- (d) Sudden weather changes on big lakes
- (e) Canal lock sluices

### 34. WATER SAFETY

- (a) Types of Flares
- (b) What to do if you see a flare
- (c) Conditions of using flares
- (d) Flares to be carried on a Scout boat
- (e) Classification of waters
- (f) Fire prevention and Fire fighting on boats

### 35. ENVIROMENTAL AND COMMUNITY

- (a) Lead an survey of 1Km
- (b) Solve a problems found in your survey
- (c) Dangers and problems of dumping
- (d) Dangers of Weil's disease

### 36. MAINTENANCE

- (a) Help regularly with the maintenance
- (b) Teach how to maintain equipment
- (c) Care for ropes
- (d) Check a boat for its seaworthiness

Complete at least two out of the following: -

- (e) Maintenance and storage of tents
- (f) Maintenance and storage of sails
- (g) Types of construction for wooden boats
- (h) Different types of hulls
- (i) Outboard or Inboard marine engines

SECTION 2 – Options, complete at least five out of the following topics

**37. HIKING**

- (a) Teach the equipment for hiking
- (b) Cooking for hike camps
- (c) Continue hiking

**38. ROPEWORK**

- (a) Double sheet bend and Rolling hitch
- (b) The back, short and eye splice
- (c) Ropes and cordage
- (d) Synthetic ropes

**39. CAMPING**

- (a) Plan a camp
- (b) Selecting a campsite
- (c) Camp gadgets
- (d) Cook a three-course meal on an open fire
- (f) Backwoods camping and cooking
- (g) Continue camping

**40. WATER ACTIVITIES**

- (a) Personal clothing and safety equipment
- (b) Equipment needed for the boat
- (c) Types of materials in small boats
- (d) Construction types for small boats
- (e) Teach the standard parts of a boat
- (f) Capsize situation
- (g) Take part in water activities
- (h) Teach how to steer a compass course

**41. ACTIVITIES AFLOAT**

OARS – “O” (Crew), SAIL – “S” (Crew or Dinghy) or POWER BOAT – “P”

- (a) Teach the commands (O)
- Teach the sailing manoeuvres
- (b) Tow and be towed (O & P)
- Show the “points of sailing”
- Move through a course (O&P)
- Simulated emergencies
- Simulated rescue
- Paddlewheel effect (P)

(i) **CANOE / KAYAK**

- (a) Slap support on both sides
- Draw and sculling draw strokes
- Ferry gliding forward and reverse
- Break in and break out of fast water
- Stern rudder, low brace and high brace
- (b) Rescue techniques

**42. FLAGS AND TRADITIONS**

- (a) How time was recorded on ships

**43. CURRENTS, TIDES AND WINDS**

- (a) Tides and terms
- (b) Tide times
- (c) Tidal currents
- (d) Waves
- (e) Tidal effects
- (f) Windward and Leeward

**44. RULES OF THE ROAD AT SEA**

- (a) Terms of the rules of the road at sea
- (b) Teach right of way
- (c) Fog signals
- (d) Fog signal made by a Scout boat
- (e) Danger signals in use